

2023 PRODUCT GUIDE

Woodworking Tools and Machinery



CARBATEC.COM.AU

1800 658 111

carbatec[®]
THE HOME OF WOODWORKING



ZETSAW
Japanese Crosscut Carpenters Saw - 300 mm

Part No. **Z-15011**

Blade for Z-15011 Japanese Universal Saw

Part No. **Z-15012** (Fine)

Blade for Z-15011 Japanese Carpenter's Rip Saw

Part No. **Z-15013** (Coarse)



ZETSAW
Japanese Crosscut Carpenters Saw - 250 mm

Part No. **Z-15006**

Blade for Z-15006 Japanese Universal Saw H-250

Part No. **Z-15007** (Fine)



ZETSAW
Japanese Fine Tooth Joinery Saw - 240 mm

Part No. **Z-7029**

Blade for Z-7029 Japanese Fine Tooth Joinery Saw

Part No. **Z-7030**



ZETSAW
Japanese General Purpose Saw - 150 mm

Part No. **Z-7010**

Blade for Z-7010 Japanese General Purpose Saw

Part No. **Z-7011**



ZETSAW
Japanese Double-Sided Flush Cutting Saw

Part No. **Z-1500**

Double-Sided Flush Cutting Replacement Blade:

Part No. **Z-1510**



ZETSAW
Japanese Single-Sided Flush Cutting Saw

Part No. **Z-150S**

Single Sided Flush Cutting Replacement Blade:

Part No. **Z-151S**



PAX SAWS
Veneer Saw

Part No. **PAX-VS**



PAX SAWS
8" Gents Saw

Part No. **PAX-G8**



PAX SAWS
22" Handsaw

Part No. **PAX-22**



PEGAS
HD Coping Saw

Part No. **PEG-49-711**



PEGAS
Premium Swiss Jewellers Saw Frame

Part No. **PEG-49-721**



PAX SAWS
12" Tenon Saw

Part No. **PAX-T12**



TOPMAN
Square Head Hammer - 115 g
 Part No. **JH-115**
 Also available in 225 g
 Part No. **JH-225**



CARBATEC
Wooden Carpenter's Mallet - 113 mm
 Part No. **CT-260420**



VERITAS
Cabinetmakers Mallet
 Part No. **05E15-01**



CARBATEC
Deadblow Hammer - 500 g
 Part No. **PU-038**
 Also available in 920 g - Part No. **PU-050**



GROZ
Nail Punch - Set of 3
 Part No. **GZ-25366**



NEW!
VERITAS
Journeyman's Small Mallet
 31 mm, 340 g
 Part No. **05K15-01**



NEW!
VERITAS
Journeyman's Large Mallet
 41 mm, 510 g
 Part No. **05K15-03**



NEW!
CARBATEC
Automatic Centre Punch Tool
 Part No. **CT-ACP**



NEW!



- 1** NAREX 140 mm Traditional Carpenters Mallet - Part No. **NRX-825300**
- 2** NAREX 290 mm Anti-Reflex Bounceless Mallet - Part No. **NRX-875102**
- 3** NAREX 170 mm Traditional Joiners Mallet - Part No. **NRX-825110**
- 4** NAREX Conical Scratch Awl - Part No. **NRX-874610**
- 5** NAREX Marking Knife - Part No. **NRX-822301**



KUTZALL
Tungsten Carbide
8" Flat Hand Rasp Fine
Part No. **KUTZ-FT8170**



KUTZALL
Tungsten Carbide
8" Flat Hand Rasp Coarse
Part No. **KUTZ-FT8330**



KUTZALL
Tungsten Carbide
6" Half-Round Rasp Fine
Part No. **KUTZ-HR6170**



KUTZALL
Tungsten Carbide
6" Half-Round Rasp Coarse
Part No. **KUTZ-HR6330**



KUTZALL
Tungsten Carbide
6" Warding Rasp Fine
Part No. **KUTZ-WD6170**



KUTZALL
Tungsten Carbide
6" Warding Rasp Coarse
Part No. **KUTZ-WD6330**



CARBATEC
8 Pce Riffler Rasp Set
Part No. **CT-RIFFLER-8PCE**



CARBATEC
Diamond File Set
Part No. **DF-10**

NEW!

NAREX
Fine Machine Cut Round
200 mm Rasp
Part No. **NRX-872562**

NAREX
Coarse Machine Cut Round
200 mm Rasp
Part No. **NRX-872512**

NAREX
Fine Machine Cut Flat
200 mm Rasp
Part No. **NRX-872552**

NAREX
Coarse Machine Cut Flat
200 mm Rasp
Part No. **NRX-872502**

NAREX
Fine Machine Cut Half Round
200 mm Rasp
Part No. **NRX-872572**

NAREX
Coarse Machine Cut Half Round
200 mm Rasp
Part No. **NRX-872522**





MTC
Japanese Bevel Edge Chisels
9 Pce set, 6-38 mm
Part No. **MBC-SET**



TOPMAN
Japanese Chisels
6 Pce set, 6-30 mm
Part No. **JCS-6**



pfeil SWISS MADE

PFEIL
Cabinet Makers Chisels
6 Pce set, 6-26 mm
Part No. **PF-CM-SET-6**



MTC
Japanese Butt Chisel 1"
Carbon Vanadium
Part No. **MBC-1-N**



MTC
Japanese Butt Chisel 1/2"
Carbon Vanadium
Part No. **MBC-12-N**



MTC
Japanese Butt Chisel 3/8"
Carbon Vanadium
Part No. **MBC-38-N**



MTC
Japanese Butt Chisel 3/4"
Carbon Vanadium
Part No. **MBC-34-N**



MTC
Japanese Butt Chisel 1/4"
Carbon Vanadium
Part No. **MBC-14-N**

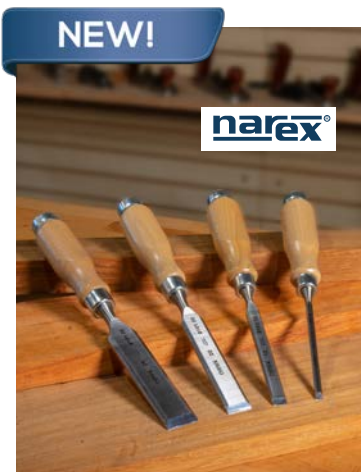

NAREX
Wood Line Bevel Edge
Chisel Set - 4 pieces
Part No. **NRX-853055**

Also available
in 6-piece set, in wooden case
Part No. **NRX-853055**



NAREX
Wood Line Plus Series
Bevel Edge Chisel Set - 4 pieces
Part No. **NRX-863201**

Also available
in 6-piece set, in wooden case
Part No. **NRX-853250**

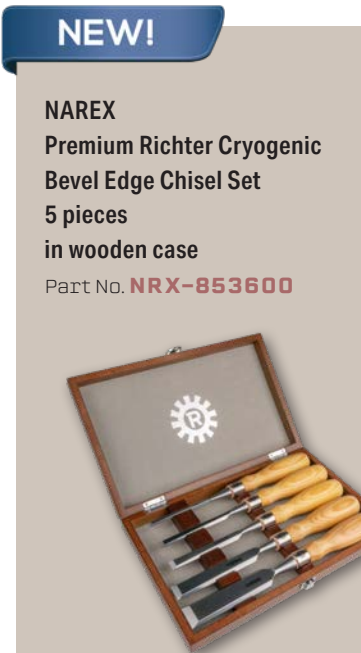

NAREX
Premium Richter Cryogenic
Bevel Edge Chisel Set
5 pieces
in wooden case
Part No. **NRX-853600**



SCRAPERS, BURNISHERS & HANDPLANES



PAX SAWS
Design From
Switzerland

PAX
Cabinet Scraper Set -
Rectangular - 4 pieces
Part No. **PAX-SS2**



PAX SAWS
Design From
Switzerland

PAX
Concave Scraper Set - 0.8 mm
3 pieces, 1/4" to 1-1/2"
Part No. **PAX-CC**



PAX SAWS
Design From
Switzerland

PAX
Convex Scraper Set - 0.8 mm
3 pieces, 1/4" to 1-1/2"
Part No. **PAX-CV**



pfeil SWISS MADE

PFEIL
Oval Burnisher
Part No. **PF-BURN-OVAL**



LeeValley

LEE VALLEY
Super Hard Cabinet Scraper Set
4 pieces
Part No. **05K30-10**



LeeValley

LEE VALLEY
Super Scraper Set
0.4 mm - 3 pieces
Part No. **05K20-20**



veritas

VERITAS
Variable Burnisher with Blade
Part No. **05K37-01**



veritas

VERITAS
Mini Carbide Burnisher
Part No. **05K20-30**



veritas

VERITAS
Scraper Holder 6"
Part No. **05K33-01**



veritas

VERITAS
Jointer/Edger
Part No. **05M07-01**



veritas

VERITAS
Large Router Plane
Part No. **05P38-01**



veritas

VERITAS
Flush Plane
Part No. **05P20-01**



GROZ
Standard Block Plane
Part No. **GZ-220N**



GROZ
Low-Angle Block Plane
Part No. **GZ-605N**



GROZ
Smoothing Plane - No. 4
Part No. **GZ-39701**



GROZ
Smoothing Plane - No. 5
Part No. **GZ-39702**



GROZ
Jointing Plane - No. 7
Part No. **GZ-39704**



VERITAS
Low Angle Smoothing Plane
with PM-V11 Blade
Part No. **05P25-71**
Optional blade also available.



VERITAS
Standard Block Plane
with PM-V11 Blade
Part No. **05P22-81**



VERITAS
Low-Angle Block Plane
with PM-V11 Blade
Part No. **05P22-71**



VERITAS
Bevel-Up Smoother Plane
with PM-V11 Blade
Part No. **05P36-71**



VERITAS
Low-Angle Jack Plane
with PM-V11 Blade
Part No. **05P34-71**



VERITAS
Round Spokeshave
with PM-V11 Blade
Part No. **05P33-74**



VERITAS
Flat Spokeshave
with PM-V11 Blade
Part No. **05P33-73**

A comprehensive range of hand tools is available.
Please contact us or visit our website for more information.



SHARPENING

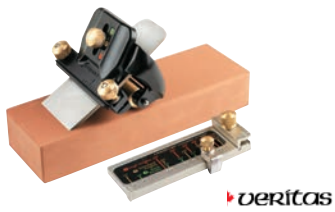

VERITAS
MK II Honing Guide
 Part No. **05M09-01**
 Sharpening stone not included.



VERITAS
Side Clamping Guide Honing Guide
 Part No. **05M09-40**



DMT
8" DiaSharp - Fine
 Part No. **DMT-D8F**
 Also available in Extra Fine
 Part No. **DMT-D8E**



DMT
8" DiaSharp - Coarse
 Part No. **DMT-D8C**
 Also available in Extra Coarse
 Part No. **DMT-D8X**



CARBATEC
Plane & Chisel Sharpening Guide
 Part No. **CSG-21**
 Diamond plate not included.



CARBATEC
Economy Honing Guide
 Part No. **MJ-817**
 Diamond plate not included.



CARBATEC
Black Granite Surface Plate
 Part No. **GSP-1**



DMT
DuoSharp Molded Base
 Part No. **DMT-B8250**

carbatec

CARBATEC
750 W (1HP) 200 mm
Low Speed Bench Grinder
 Part No. **GR-S200P**



CARBATEC
Aluminium Oxide Grinding Wheel
200 mm - 80 Grit
 Part No. **KINIK-200**
 Also available in 150 mm.



CARBATEC
Bench Grinder Tool Rest Kit
 Part No. **CT-CGJ-01**



CARBATEC
Bench Grinder Jig Accessory Kit
 Part No. **CT-CGJ-ASSY**



CARBATEC
200 mm CBN Grinding Wheel
25 mm x 5/8" Bore - 180 G
 Part No. **CT-CBN2002558**

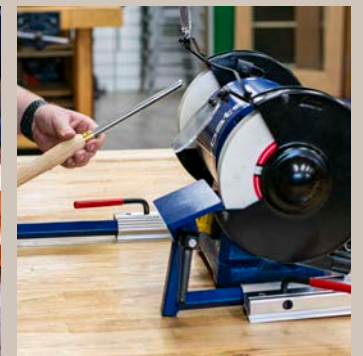

CARBATEC
Spindle and Gouge
Sharpening System
 Part No. **CT-SGSS-01**



TORMEK Square Edge Jig
Part No. **TOR-SE-77**



TORMEK Truing Tool
Part No. **TOR-TT-50**



TORMEK Tool Rest Jig
Part No. **TOR-SVD-110**



TORMEK T8 Water Cooled Grinder
Part No. **TOR-T8**



TORMEK T4 Sharpening System
Part No. **TOR-T4**



Robert Sorby

ROBERT SORBY ProEdge Ceramic Belt 120 grit

Part No. **RSB-WPE120C**
Also available in 60 grit -
Part No. **RSB-WPE60C**



Robert Sorby

ROBERT SORBY ProEdge Aluminium Oxide Belt 120 grit

Part No. **RSB-WPE120A**
Also available in:
60 grit - Part No. **RSB-WPE60A**
240 grit - Part No. **RSB-WPE240A**

Robert Sorby



Robert Sorby

ROBERT SORBY ProEdge Angle Setting Guide
Part No. **RSB-WPROSET**



Robert Sorby

ROBERT SORBY ProEdge Woodworkers' Square Guide
Part No. **RSB-WPESQW**

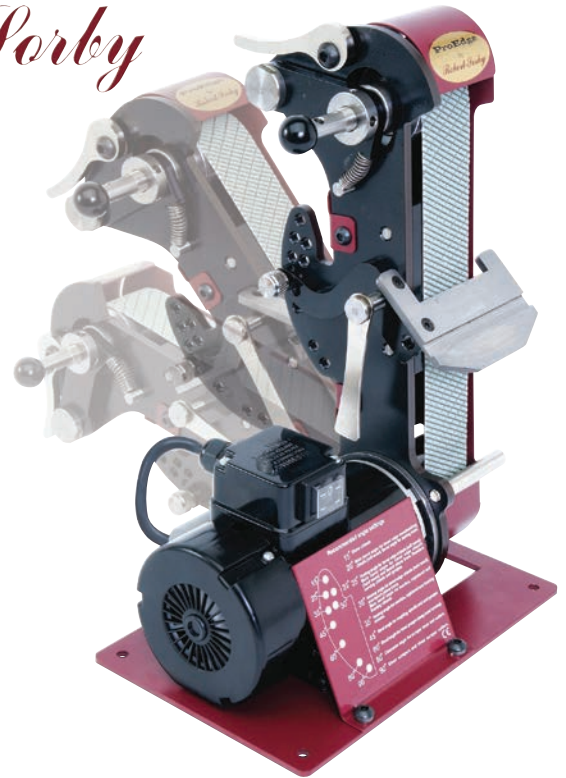

ROBERT SORBY ProEdge Deluxe Sharpening System
Part No. **RSB-WPED01D**



carbatec

CARBATEC
Woodworking T-Square - 160 mm

Part No. **CT-IM-TS160**
Also available in 100 mm and 260 mm



carbatec

CARBATEC
Combination Square Set
Part No. **CSQ-1625**



TOPMAN
Japanese Try Square
Part No. **49N0502**



TOPMAN
Shinwa Carpenter's Square
30 x 15 cm
Part No. **JTM-1884-008**



TOPMAN
Shinwa Straight Scale Rule
with stopper - 150 mm
Part No. **JTM-1929-310**



TOPMAN
Shinwa Ruler Pick Up Scale
Silver - 30 cm
Part No. **JTM-1929-003**

INCRA

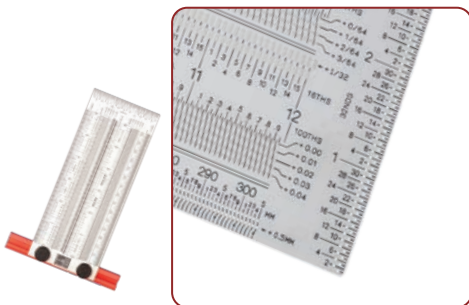

INCRA
Professional T-Rule - 150 mm
Part No. **IN-TDPROT06**
Also available in 300 mm: Part No. **IN-TDPROT12**



INCRA
Centring Rule - 300 mm
Part No. **IN-CENT300M**



INCRA
Precision Protractor 160 mm
Part No. **IN-PRO160M**



INCRA
Precision Bend Rule - 300 mm
Part No. **IN-BND300M**
Also available in 150 mm:
Part No. **IN-BND150M**



INCRA
Rule - 150 mm
Part No. **IN-TRUL150M**
Also available in 300 mm: Part No. **IN-TRUL300M**

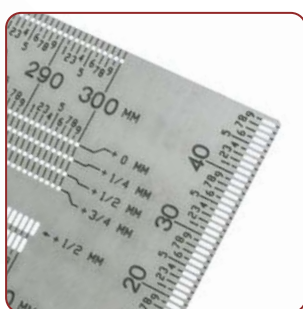



carbatec

CARBATEC
Flexible Curve With Ruler
600 mm

Part No. **D-00503**



carbatec

CARBATEC
Steel Ruler - 150 x 18 mm

Part No. **RU-150W**



veritas

VERITAS
Set of 3 Metric Edge Rules

Part No. **05N46-50**



GROZ

GROZ
Stainless Steel Rule - 600 mm

Part No. **GZ-01343**

Also available in 1000 mm:

Part No. **GZ-01344**



carbatec

CARBATEC
Carbatec Self Adhesive Rule -
762 mm (30")

Part No. **76030**



KREG
3.5 Metre
Right to Left Tape

Part No. **KR-KMS7728**

Also available in Left to Right:

Part No. **KR-KMS7729**

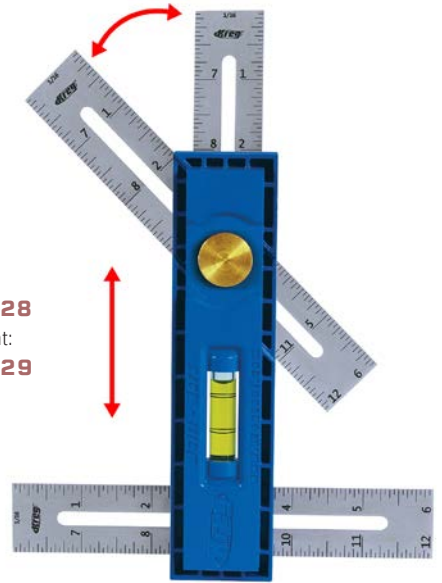

KREG
Multi Mark

Part No. **KR-KMA2900**



SOBA

SOBA
9" Rosewood Sliding Bevel

Part No. **CT-260435**



SOBA

SOBA
Rosewood & Brass 45°
Mitre Square

Part No. **CT-260505**



VERITAS
Wheel Marking Gauge

Part No. **05N33-21**



VERITAS
Metric Graduated Marking Gauge

Part No. **05N35-21**



VERITAS
Dual Marking Gauge

Part No. **05N70-01**

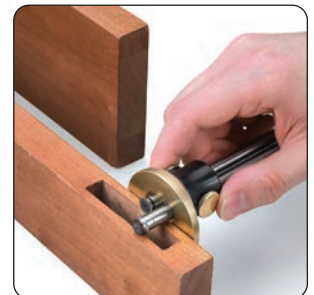

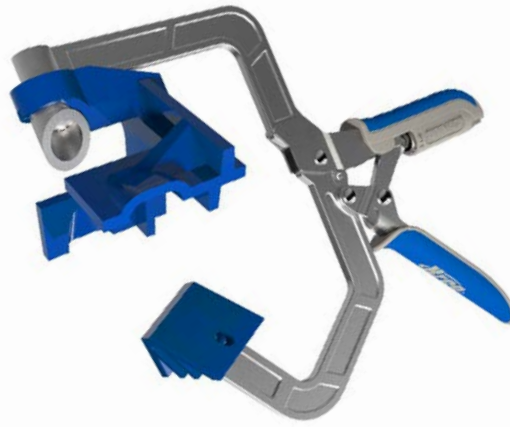

**KREG
Automaxx™ 90°
Corner Clamp**

Part No.

KR-KHCCC



**KREG
3" Face Clamp**

Part No. **KR-KHC-PREMIUM**



**KREG
3" Automaxx™
Wood Project Clamp**

Part No. **KR-KHC3**



**KREG
6" Automaxx™
Wood Project Clamp**

Part No. **KR-KHC6**



**KREG
Automaxx™
Right Angle Clamp**

Part No. **KR-KHCRA**



**ROCKLER
Frame Clamp Kit**

Part No. **RK-17477**



**ROCKLER
Heavy Duty Clamp Rack**

Part No. **RK-57164**

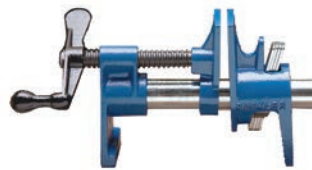

**ROCKLER
Sure-Foot Plus
3/4" Pipe Clamp**

Part No. **RK-30921**

Pipe not included



**ROCKLER
36" Sure-Foot Aluminium
Bar Clamp (900 mm)**

Part No. **RK-41815**

Also available in 48" (1200 mm)

Part No. **RK-41816**



**ROCKLER
F-Style Clamp Rack**

Part No. **RK-34302**

Clamps not included



**ROCKLER
Pipe Clamp Rack/
Bar Clamp Rack**

Part No. **RK-33547**

Clamps not included



carbatec



CARBATEC Mitre Clamp
Part No. **CT-7901**



CARBATEC External Mitre Clamp
Part No. **TV-286**
Also available: Internal Mitre Clamp
Part No. **TV-276**



CARBATEC Clamping Squares
Part No. **SQS-1**



CARBATEC Double Bar Clamp
Single clamp hardware only
Part No. **YF-00101**



CARBATEC Band Clamp Cloth
Max 3.5m
Part No. **96601**

wolcraft®



WOLFCRAFT EHZ "PRO" One-Hand Clamp
300 mm capacity
Part No. **WLF-PRO-65300**
Available from 150-300 mm



WOLFCRAFT EHZ "PRO" One-Hand Clamp
300 mm capacity, Range 1
Part No. **WLF-PRO-100300**
Available from 150-915 mm



WOLFCRAFT EHZ Miniature One-Hand Clamps
(2 Pack) - 110 mm capacity
Part No. **WLF-EASY-40110**



WOLFCRAFT EHZ "Easy" One-Hand Clamp
150 mm capacity, Range 1
Part No. **WLF-EASY-75150**
Available from 190-500 mm



WOLFCRAFT KS 24 Edge Clamp
Part No. **WLF-EDGECLAMP**



WOLFCRAFT FZH Spring Clamp with Hook
Part No. **WLF-FZH50HANG**



WOLFCRAFT Connector PRO/Easy One-Hand Clamp Adapter
Part No. **WLF-EHZ-CONNECT**



WOLFCRAFT ES 22 Corner Clamp (2 Pack)
Part No. **WLF-ES22-2PK**



WOLFCRAFT FZH Ergo Spring Clamp
Part No. **WLF-FZH30**
Also available:
FZH Ergo Spring Clamp 2



WOLFCRAFT FZ Spring Clamp Range 1
Part No. **WLF-FZ40**
Also available:
FZ Spring Clamp Range 2



WOLFCRAFT Microfix Mini Spring Clamp
Part No. **WLF-MFIX20**
Colour may vary



WOLFCRAFT Microfix Spring Clamps (4 Pack)
Part No. **WLF-MFIX30-4PK**



WOLFCRAFT Microtip 60 Precision Spring Clamps (2 Pack)
Part No. **WLF-MTIP-2PK**



GROZ
150 mm Clamp-On Woodworking Vice
Part No. **GZ-39006**



GROZ
T-Bar Clamp
750 mm capacity
Part No. **GZ-39100**

Also available in:

1050 mm capacity - Part No. **GZ-39101**

1350 mm capacity - Part No. **GZ-39102**

1660 mm capacity - Part No. **GZ-39103**

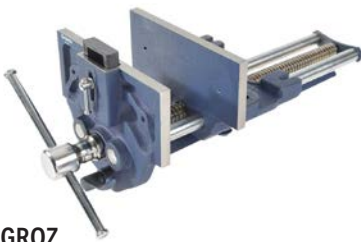

GROZ
222 mm Quick-Release Vice
Part No. **GZ-39009**



GROZ
175 mm Quick-Release Vice
Part No. **GZ-39007**

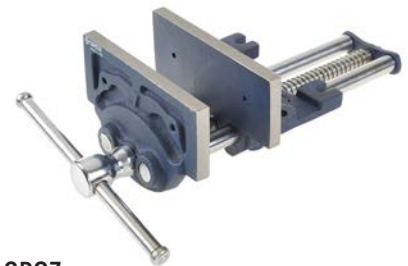

GROZ
175 mm Plain Screw Vice
200 mm capacity
Part No. **GZ-39001**



More than ninety
BESSEY clamping solutions
at carbatec.com.au



BESSEY
I-profile Sash Clamp
1800 mm
Part No. **BES-TL180**

Also available in:
1200, 900 and 600 mm



BESSEY
K Body Revo 2.0 Clamp
2500 mm
Part No. **BES-KRE250-2K**

Also available in:
2000, 1500, 1250, 1000, 800,
600, 300 mm



BESSEY
Hold-Down Workbench Clamp
Part No. **TW162010-2K**



BESSEY
Powergrip One Hand Clamp
600 mm
Part No. **BES-EHZ60-2K**

Also available in 300 mm



1
CARBATEC
 Tail Vice Hardware
 Part No. **CT-TV**

2
CARBATEC
 Shoulder Vice Hardware
 Part No. **CT-SV**

3
CARBATEC
 Regular Front Vice Hardware
 Part No. **CT-FV-R**

4
CARBATEC
 Large Front Vice Hardware
 Part No. **CT-FV-L**

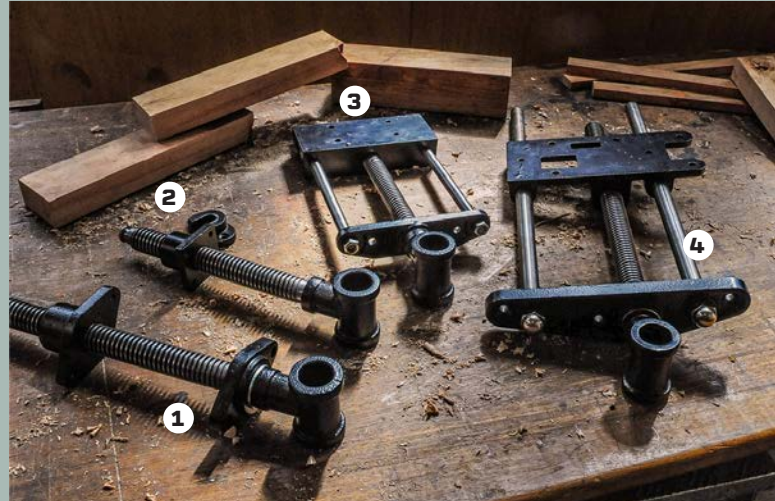

5
CARBATEC
 Swivelling Bench Vice 150 mm
 Part No. **CT-SBV150**

6
CARBATEC
 Swivelling Bench Vice 100 mm
 Part No. **CT-SBV100**

7
CARBATEC
 Clamp on Swivel Head Vice
 Part No. **CT-SHV060**

8
CARBATEC
 125mm Swivelling & Rotating
 Bench Vice
 Part No. **CT-SHV125**

9
CARBATEC
 Low Profile Vice
 Part No. **CT-LPV**

CARBATEC
 Wide Foot Pipe Clamp Head
 Part No. **CT-PIPE**

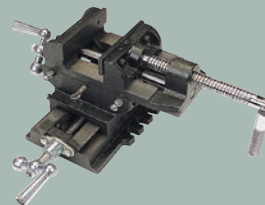

CARBATEC
 4" Cross Slide Vice
 Part No. **CSV-4**



CARBATEC
 Parrot Vice
 Part No. **PARROT-VISE**

CARBATEC
 Pattern Makers and Guitar or
 Luthier's Vice
 Part No. **PATTERN-VISE**

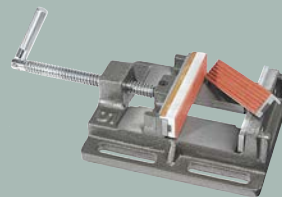

CARBATEC
 4" Drill Press Vice
 Part No. **GD-134/4**



CARBATEC
 Heavy Duty Carver's Vice
 Part No. **CV-236**

FESTOOL 4 Schools

The Festool 4 Schools program has been designed to provide schools, colleges and TAFEs all around Australia with access to tools that make both learning and teaching faster, easier and safer.



FESTOOL TS 55F 160 mm Plunge Cut Circular Saw in Systainer
Part No. **FE-576705**



FESTOOL TS 55F 160 mm Plunge Cut Circular Saw in Systainer with 1400 mm Rail
Part No. **FE-577281**



FESTOOL OF 1400 70 mm Plunge Router in Systainer
Part No. **FE-576211**
Also available in 80 mm:
Part No. **FE-576217**

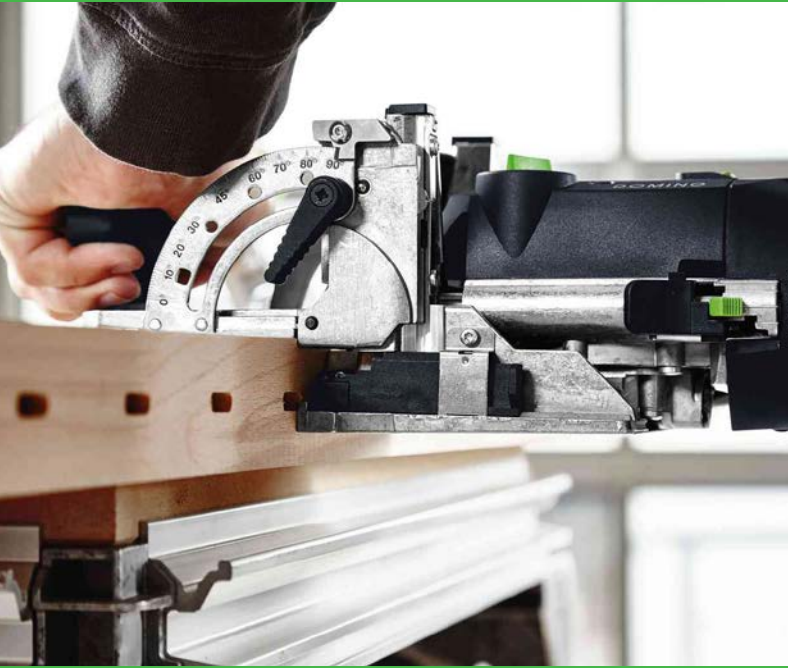

FESTOOL DF 500 DOMINO Joining Machine in Systainer
Part No. **FE-574328**
Also available:
DF 700 DOMINO XL Joining Machine Plus in Systainer
Part No. **FE-576429**



FESTOOL Domino XL Beech 8 mm / 10 mm Starter Systainer Set
Part No. **FE-498204**
Available in:
4 mm / 10 mm Part No. **FE-576794**
12 mm / 14 mm Part No. **FE-576792**



FESTOOL KS 120R KAPEX 260 mm Slide Compound Mitre Saw
Part No. **FE-575307**

FESTOOL 4 Schools

10% OFF Festool tools

10% OFF Festool accessories and consumables

FREE Demonstrations and training sessions

FESTOOL



FESTOOL
RO 150 mm Rotex 3 en 1
Random Orbital Sander
in Systainer
Part No. **FE-576019**



FESTOOL
ETS 150 mm Random Orbital Sander
in Systainer
Part No. **FE-576076**



FESTOOL
ETS 150 mm Random Orbital 5 mm Sander
in Systainer
Part No. **FE-576084**



FESTOOL
CT 15 Litre HEPA Class Dust Extractor
Part No. **FE-577414**



FESTOOL
CTM 26 Litre M Class Dust Extractor
Part No. **FE-575758**



FESTOOL
CTM 36 Litre M Class Dust Extractor
Part No. **FE-576741**



TRITON
SuperJaws XXL Portable
Clamping System
Part No. **TRI-SJA100XL**



TRITON
2400W Dual Mode Precision Plunge Router
Part No. **TRI-TRA001B**



NEW!

TRITON
650W Portable Oscillating
Spindle Sander
Part No. **TRI-TSPSP650**



Find all the Carbatec router table kit options and the accessories available individually at carbatec.com.au



CARBATEC Router Table Mitre Gauge
Part No. **RT-MITREGAUGE**



CARBATEC Router Table Premium Guard
Part No. **RT-GUARDASSY**

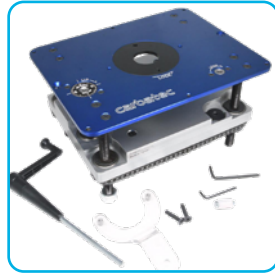

CARBATEC Lift N Lock Router Lift
Part No. **RT-LIFT-UNI**

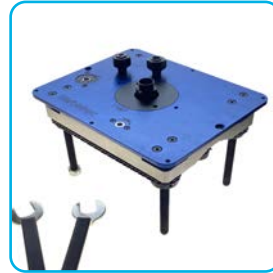

CARBATEC Lift N Lock Router Lift Suits fixed base routers
Part No. **RT-LIFT-FB**



CARBATEC 2400W Router Power Unit
Part No. **RT-RPU2400**



Height adjustable enclosed guard with rear dust port

Micro-adjustable fence with shifting zero adjustable scales



CARBATEC Compact Precision Router Table Fence
Part No. **RT-FENCE-S**
Available in two sizes.



Repositionable accessory storage rack

Solid core phenolic resin. Also available in precision-milled cast iron



CARBATEC Pro Cast Iron Router Table Top only
Part No. **RT-TABLECAST-S**
Available in two sizes.

- INCLUDES:**
- Stand with levellers
 - Phenolic top
 - Router lift
 - 2400 W router power unit
 - Aluminium fence with micro adjusters & flip stop
 - Mitre gauge
 - Stand-mounted remote NVR power switch



CARBATEC Replacement Remote NVR Power Switch for Router Tables
Part No. **RT-SWTASY**

CARBATEC Pro Powered Deluxe Router Table Kit with Phenolic Top
Part No. **RT-XP810-P**

A huge range of CMT and ARDEN individual router bits and bit sets are available.



carbatec

CARBATEC
Brass Router Bushing Set
Part No. **RM-9**



carbatec

CARBATEC
Universal Router Base Plate
Part No. **CT-BPA-1**



triton

TRITON
Template Guide Kit -
12 pce
Part No. **TRI-TGA250**

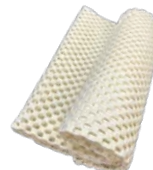

carbatec

CARBATEC
Router Mat - 900 x 600
Part No. **P-2436**



ROCKLER
WOODWORKING AND HARDWARE

ROCKLER
2 1/4 Interlock Signmaker's
Lettering Kit
Part No. **RK-30610**



KREG
Large Router Table System
Part No. **KR-PRS1045**



Kreg

KREG
Benchtop Router Table
Part No. **KR-PRS2100**

carbatec

CARBATEC

Brad Point Bit Set

1, 1.5, 2, 2.5, 3, 3.5,
4, 4.5, 5, 5.5, 6, 6.5,
7, 7.5, 8, 8.5, 9, 9.5,
10, 10.5, 11, 11.5, 12,
12.5 & 13 mm

Part No.
BPD-25PCE



carbatec

CARBATEC

16 Piece Sawtooth & Forstner Combination Bit Set- Metric

Part No. **CT-STB16PCE-M**

Also available in imperial

Part No. **CT-STB16PCE-I**

carbatec



CARBATEC
5 Piece Forstner Style Bit Set

Part No.
FSB-5PCE-M



CMT

CMT
5 Piece Brad Point Drill Set

Part No.
517-001-00



CMT

CMT
8 Piece Brad Point Drill Set

Part No.
517-002-00



carbatec

CARBATEC
Carbatec Forstner Bit Extension

Part No. **EXTN-1**



carbatec

CARBATEC
Drill & Barrel Plug 8pce cutter Set Small

Part No. **PSG-8PCE-S**



carbatec

CARBATEC
Drill & Barrel Plug 8pce cutter Set Large

Part No. **PSG-8PCE-L**



ARCHER

ARCHER
Archer 8 Piece Plug cutter Set

Part No. **PCS-8PCE**



veritas

VERITAS
Metric Snug Plug cutter Set - 3 pce

Part No. **05J05-50**



carbatec

CARBATEC
6 Piece Barrel Plug cutter Set

Part No. **PLUG-6**

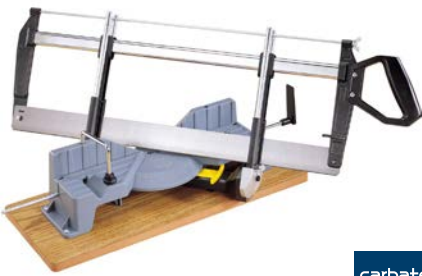

carbatec

CARBATEC
Compact Mitre Box - 600 mm Blade

Part No. **CPTC-600**

Replacement blades available for:

CPT-600 - 24Tpi - Part No. **CPTC-600-24T**

CPT-600 - 18Tpi - Part No. **CPTC-600-18T**

CPT-600 - 14Tpi - Part No. **CPTC-600-14T**

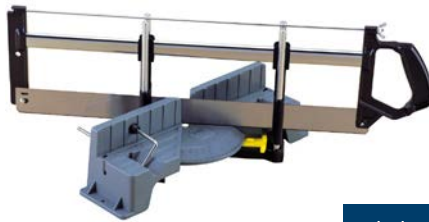

carbatec

CARBATEC
Compact Mitre Box - 550mm Blade

Part No. **CPT-550**

Replacement blades available for:

CPT-550 - 24Tpi - Part No. **CPT-550-24T**

CPT-550 - 18Tpi - Part No. **CPT-550-18T**



carbatec

CARBATEC
Compact Mitre Box - 350mm Blade

Part No. **CPT-350**

Replacement blades available for:

CPT-350 - 14Tpi - Part No. **CPT-350-14T**

CPT-350 - 18Tpi - Part No. **CPT-350-18T**



carbatec

CARBATEC
Mitre Trimmer

Part No. **CT-MT**

Replacement blades available:

Part No. **CT-MT-BLADE**



ZETSAW
Japanese Compound
Saw Guide and
S-265 KATABA Set

Part No. **Z-8008**

Replacement blade available:

Part No. **Z-8008-B**





LEIGH
Super Jig 12" (305 mm) with Metric Scales

Part No. **LGH-SJ12M**

Also available in 18" (457 mm)

Part No. **LGH-SJ18M**



LEIGH
D4R Pro Dovetail Jig with Metric Scales

Part No. **LGH-D4R**



LEIGH
RTJ400 Router Table Dovetail Jig

Part No. **LGH-RTJ400**



LEIGH
GBS Adaptor to suit
some Hitachi and Makita

Part No. **LGH-703**



LEIGH
Router Bit Set 51168 - for D4R Jig

Part No. **LGH-51168**



CMT
Dovetail Router Bit - 10°

Part No. **818-133-11**



CARBATEC
14" Dovetail Bit

Part No.

CT-DTJ300-DB14

CARBATEC
Half Blind Dovetail Jig 300 mm with Router Bit

Part No. **CT-DTJ300**





KREG
Wood Blue-Kote Screw Kit
Part No. **KR-SK03B**



KREG
Wood Pocket-Hole Screw Kit
Part No. **KR-SK03**



KREG
HD Pocket Hole Jig XL
Part No. **KR-KPHJ920**



KREG
320 Pocket-Hole Jig
Part No. **KR-KPHJ320**



KREG
520PRO Pocket-Hole Jig
Part No. **KR-KPHJ520PRO**



KREG
720PRO Pocket-Hole Jig
Part No. **KR-KPHJ720PRO**



SawStop's patented safety system stops a spinning blade on contact with skin. The blade stops in less than 5 milliseconds and drops below the table, minimising a potentially life-altering injury to a mere scratch.



SAWSTOP PROFESSIONAL Cabinet Saw with 36" T-Glide Rail

Part No. **SST-PCS36TGLIDE**

- 2200 W (3 HP) induction
- Max rip capacity: 914 mm
- Footprint (WxDxH): 1770x1060x1050 mm

Also available:

- Professional Cabinet Saw with 30" Premium Rail (SST-ICS52TGLIDE)
- Professional Cabinet Saw with 52" T-Glide Rail (SST-PCS52TGLIDE)



SAWSTOP INDUSTRIAL Cabinet Saw with 36" T-Glide Rail

Part No. **SST-ICS36TGLIDE**

- 2200 W (3 HP) induction
- Max rip capacity: 914 mm
- Bigger hand wheels, larger motor access door, second access door
- Perfect for high cycle environments
- 90 kg+ of cast iron and steel
- Thicker and deeper cast iron table
- Larger and deeper T-Glide fence
- Safety switch on access doors
- Footprint (WxDxH): 1755x1015 mm

Also available:

- Industrial Cabinet Saw with 52" T-Glide Rail (SST-ICS52TGLIDE)
- 3 Phase Industrial Cabinet Saw with 36" Industrial Fence (SST-ICS36TGLIDE3)
- Industrial Cabinet Saw 5HP 415V 3PH with 52" Premium T-Glide Fence System (SST-ICS52TGLIDE3)



SAWSTOP Dust Collection Arm

Part No. **SST-TSAODC**



SAWSTOP Industrial Mobile Base for Professional Cabinet Saw

Part No. **SST-PCS-MBIND**



SAWSTOP Integrated Mobile Base for Professional Cabinet Saw

Part No. **SST-MBPCS000**



SAWSTOP 10" Standard Brake

Part No. **SST-TSBC10R2**



SAWSTOP Large Sliding Table

Part No. **SST-TSA-SA70**



SAWSTOP Sliding Crosscut Table

Part No. **SST-TSASA48**



SAWSTOP Folding Outfeed Table

Part No. **SST-TSA-FOT**



SAWSTOP Floating Overarm Dust Collection

Part No. **SST-TSG-FDC**

Schools switch options are available. Please contact us for further information.

* Carbatec supplied machinery meet all applicable Australian standards. Please confirm that individual specifications meet relevant State or Territory specific school OHS Requirements.



SAWSTOP
40 Tooth Titanium Series Blade
Part No. **SST-BTSR40ATB**



SAWSTOP
80 Tooth Titanium Series Blade
Part No. **SST-BTSP80HATB**



SAWSTOP
Standard 40 Tooth 10" Blade
Part No. **SST-CNS07148**
Also available in 60 teeth:
Part No. **SST-CB104184**



SAWSTOP
24T Ripping Blade
Part No. **SST-BTSR24ATB**



AMANA TOOLS
10" Prestige Electro-Blu Flat
Tooth Grind Ripping Blade
Part No. **AM-610240C**



CMT
Industrial Rip and Crosscut
Blade - 250mm - 60 Tooth
Part No. **285-060-10M**



CMT
Industrial Low Noise and
Chrome Coated Blade -
80 Tooth 15° - ATB Grind
Part No. **285-680-10M**



CMT
Precision Dado Set - 203 mm (8")
5/8" bore
Part No. **230-524-08**



LAGUNA

LAGUNA
2021 Fusion 2 F2 Table Saw
Part No. **LGT-FUSION2**

- 1300W (1.75 HP)
- Max rip capacity: 910 mm right, 430 mm left
- Dado capable 19 mm max.
- Footprint (WxDxH): 1663x1652x1081 mm



SAWSTOP
Premium 8" Dado Set
Part No. **SST-BTSDS82402**



carbatec

CARBATEC
Reducing Bush
30 mm to 5/8" x 2 mm
Part No. **BU-30-58**



LAGUNA

LAGUNA
2021 Fusion 3 F3 Table Saw
Part No. **LGT-FUSION3-36**

- 2200W (3 HP)
- Max rip capacity: 910 mm right, 430 mm left
- Dado capable 19 mm max.
- Cast iron cabinet mount trunnion
- Outfeed table
- 36" steel rails
- Footprint (WxDxH): 1663x1652x1081 mm

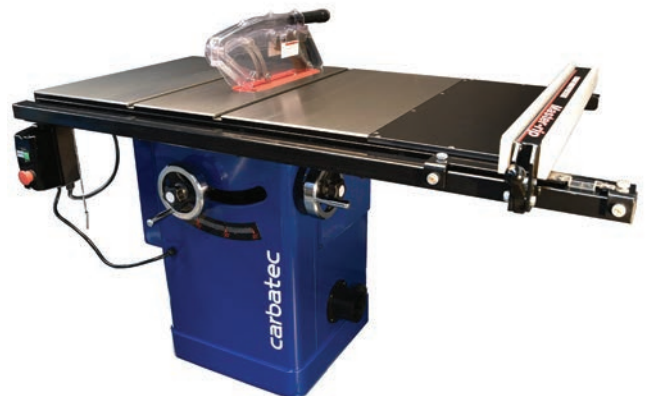

carbatec

CARBATEC
Professional 250mm Cabinet Saw
with 30" T-Glide Fence Kit
Part No. **TS-C250P-30TG**

- 1875 W (2 1/2 HP) induction
- Max rip capacity: 780 mm
- Dado capable
- Footprint (WxDxH): 1520x980x1060 mm

Many other saw blade options are available. Please contact us or visit our website for further information.

* Carbatec supplied machinery meet all applicable Australian standards. Please confirm that individual specifications meet relevant State or Territory specific school OHS Requirements.



LAGUNA

LAGUNA
Laguna 16" 3 HP
Sheartec II Thicknesser

- Part No. **LGT-TH-16**
- 2200 W (3 HP) induction motor
 - Sheartec II helical cutterhead
 - Max. cutting width 406 mm
 - Integral digital height gauge



LAGUNA

LAGUNA
20" 5 ½ HP (3 phase)
Sheartec II Thicknesser

- Part No. **LGT-TH-20-3PH**
- 4100 W (5 ½ HP) 3 phase induction motor
 - Sheartec II helical cutterhead
 - Max. cutting width 508 mm
 - Integral digital height gauge

CARBATEC
20" 3 ½ HP Thicknesser with
Helical Cutterhead

- Part No. **TH-X508C**
- 2600 W (3 ½ HP) induction motor
 - True helical cutterhead with 98 insert knives
 - Max. cutting width 508 mm

Also available:
20" 5 HP Thicknesser with Helical
Cutterhead 3 Phase
Part No. **TH-X508C-3P**



NEW!

Best value replacement carbide inserts
now available.

Carbatec Premium Carbide Inserts
14.33x2mm Square - 2 edges
Pk10

Part No. **CTI-143320-Z2**
Available in 6 varieties.



carbatec

CARBATEC
15" 3 ½ HP Thicknesser
with Helical Cutterhead

- Part No. **TH-X381C**
- 2600 W (3 1/2 HP) induction motor
 - True helical cutterhead with 74 insert knives
 - Max. cutting width 381 mm



Instead of one full width blade striking the board, a true helical cutterhead features a series of smaller, four-sided solid carbide knives, wrapped around the cutterhead in a helical pattern. They carefully 'slice' their way through even the hardest of timber grain. Far quieter, far smoother finish than with a single blade.

Schools switch options are available. Please contact us for further information.

*Carbatec supplied machinery meet all applicable Australian standards. Please confirm that individual specifications meet relevant State or Territory specific school OHS Requirements.



LAGUNA
6" Jointer - Helical Head / Parallelogram Bed
 Part No. **LGT-JN-6**

- 1100 W (1 ½ HP) induction motor
- Integral mobile base
- Sheartec II helical cutterhead, 21 inserts
- Max. cutting width 152 mm



LAGUNA
8" Jointer - Helical Head / Parallelogram Bed
 Part No. **LGT-JN-8**

- 2200 W (3 HP) induction motor
- Integral mobile base
- Sheartec II helical cutterhead, 30 inserts
- Max. cutting width 203 mm



CARBATEC
8" Long Bed Helical Cutterhead Jointer with Parallelogram Tables
 Part No. **JN-X200C**

- 1100 W (1 ½ HP) induction motor
- Integral mobile base
- Parallelogram bed adjustment
- 4" Dust port
- Max. cutting width 200 mm

Also available with straight blade.



CARBATEC
6" Long Bed Helical Cutterhead Jointer with Parallelogram Tables
 Part No. **JN-LX150C**

- 750 W (1 HP) induction motor
- Integral mobile base
- 4" Dust port
- Max. cutting width 150 mm

Also available with straight blade.

NEW!

Carbatec Premium Carbide Inserts are available in 6 varieties.



CARBATEC
Workshop LED Lamp with Articulated Arm
 Part No. **JW-55NTL-LED**



CARBATEC
Workshop LED Magnifying Lamp
 Part No. **CT-30LEB-LED**



CARBATEC
Twin Featherboard Set
 Part No. **CT-FB-2PCE**



CARBATEC
Mitre Gauge
 Part No. **MGT-02**

Schools switch options are available. Please contact us for further information.
 * Carbatec supplied machinery meet all applicable Australian standards. Please confirm that individual specifications meet relevant State or Territory specific school OHS Requirements.



BORA

BORA
Heavy Duty Adjustable Mobile Base

Part No. **BORA-PM-2500**



BORA

BORA
Heavy Duty Mobile Base - All Swivel Wheels

Part No. **BORA-PM-3550**



BORA

BORA
PM-950 Workbench Caster Kit - Set of 4

Part No. **BORA-PM-950**



BORA

BORA
Universal Customisable Mobile Base

Part No. **BORA-PM-1100**



BORA

BORA PORTAMATE
Sheet Panel Carrier

Part No. **BORA-PM-1800**



carbatec

CARBATEC
Omni-Directional Mobile Base

Part No. **CT-MB-OMNI**

CARBATEC Tilt Table Panel Carrier

Part No. **CT-TILT-TABLE**

- Height adjustable for various applications
- Use for safe sheet transport right up to your saw
- Lockable tilt function for use as additional work surface
- Highly mobile with four swivelling wheels
- Customise yours with ample storage underneath

carbatec





TRITON
TSPS T450 450 W
Oscillating Spindle & Belt Sander
 Part No. **TRI-TSPST450**

- Large cast aluminium table with 0-45° tilting
- Rotating and vertically oscillating sanding action
- 450 W motor
- 5 different spindles included
- 80/150/240 G sleeve packs available



carbatec

CARBATEC
300 mm Disc Sander
with Brake & Half Guard
 Part No. **DS-B300H**

- 900 W (1-¼ HP) induction motor,
- 300 mm hook & loop sanding disc
- Easy adjust tilting table 0-45°
- Includes brake and half guard

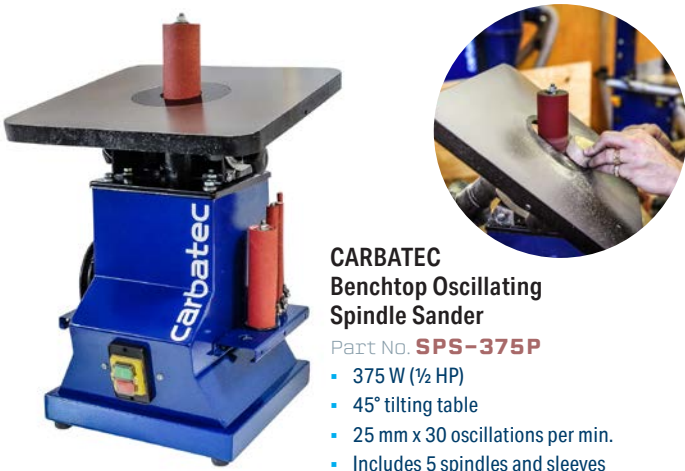

carbatec

CARBATEC
Benchtop Oscillating
Spindle Sander
 Part No. **SPS-375P**

- 375 W (½ HP)
- 45° tilting table
- 25 mm x 30 oscillations per min.
- Includes 5 spindles and sleeves

NEW!



CARBATEC
Belt/Disc Sander
6"x12"
 Part No. **BDS-1530P**

- New Larger 'P' shaped sanding table on disc
- 1100 W (1-½ HP)
- 3/4" mitre track on both tables
- Includes mitre gauge and abrasives

carbatec



carbatec

CARBATEC
Oscillating Edge Sander
 Part No. **WBS-2200C**

- 2200 W (3 HP) induction motor
- Height adjustable table
- 150 mm wide tilting belt
- Footprint (WxDxH): 1270x570x1200 mm



carbatec

CARBATEC
Belt/Disc Sander with Stand
6" x 9"
 Part No. **BDS-1523H**

- Powerful ¾ HP motor
- Belt size 150x2260 mm
- Hook and load disc
- Footprint (WxDxH): 740x520x1400 mm



LAGUNA

LAGUNA Supermax 19/38 Wide Drum Sander CE Model

Part No. **LGT-WDS-1938**

Stand not included

- 1350 W (1-3/4 HP) induction motor
- 482 mm single pass / 965 mm double pass capacity
- Variable belt feed speed
- Footprint (W×D×H): 610×1016×610 mm (without stand)



LAGUNA

LAGUNA Supermax 25/50 Wide Drum Sander CE Model

Part No. **LGT-WDS-2550**

Stand not included

- 1350 W (1-3/4 HP) induction motor
- 635 mm single pass / 1270 mm double pass capacity
- Variable belt feed speed
- Footprint (W×D×H): 1170×685×610 mm (without stand)



LAGUNA

LAGUNA Supermax 19/38 or 25/50 Closed Cabinet Mobile Stand

Part No. **LGT-WDS-STD-CLOS**



LAGUNA

LAGUNA Supermax 19/38 or 25/50 Open Stand

Part No. **LGT-WDS-STD-OPEN**

Wheels and sander not included



carbatec

CARBATEC 635 mm Wide Drum Sander - Twin Drum

Part No. **WDS-630C**

- 2200 W (3 HP) induction motor
- 635 mm wide sanding capacity
- 135 mm maximum stock thickness
- Independent drum adjustment
- Footprint (W×D×H): 1130×780×1300 mm



LAGUNA

LAGUNA SuperMax 16/32 Wide Drum Sander with stand CE Model*

Part No. **LGT-WDS-1632**

- 1100 W (1-1/2 HP) induction motor
- 405 mm single pass / 810 mm double pass capacity
- Quick adjust lever
- Footprint (W×D×H): 860×560×550 mm (without stand)

See page 42 for available sanding wrap options. Schools switch options are available. Please contact us for further information.

* Carbatec supplied machinery meet all applicable Australian standards. Please confirm that individual specifications meet relevant State or Territory specific school OHS Requirements.

carbatec

**CARBATEC
Benchtop
Drill Press**
Part No. **DP-B550P**

- 550 W (¾ HP) induction motor
- 16 speed
- 320 mm swing
- 320 mm chuck to table
- MT2



carbatec

**CARBATEC
Pedestal Drill Press**

Part No. **DP-750P**

- 750 W (1 HP) induction motor
- 16 speed
- 360 mm swing
- 680 mm chuck to table
- MT2



carbatec

**CARBATEC
Extra Heavy Duty
Pedestal Drill Press**

Part No. **DP-1500C**

- 1500 W (2 HP) induction motor
- 12 speed
- 510 mm swing
- 550 mm chuck to table
- MT4



carbatec

**CARBATEC
Radial Arm Drill Press**

Part No. **DP-R375H**

- 375 W (½ HP) induction motor
- 5 speed
- Max. 840 mm swing
- 700 mm chuck to table
- MT2



Nova Drill Presses

The world's most advanced drill press range, with unparalleled performance and versatility. Designed to handle a wide variety of materials with ease, using powerful direct drive motor technology. They run quieter and without vibration due to their belt-less design. RPM and torque are computer controlled. Electronic variable speed control in both forward and reverse directions and automatic cut off at preselected depth.

nova™

**NOVA
Voyager DVR Drill Press**

Part No.

TK-DVR-DRILLPRES

- 1500 W (2 HP) direct drive motor
- 50-5500 rpm variable speed
- 450 mm swing
- 587 mm chuck to table
- MT2



**NOVA
Viking 16" DVR Drill Press
Floor Standing Model**

Part No.

TK-VIKING-FL

- 750 W (1 HP) direct drive motor
- 150-6000 rpm variable speed
- 406 mm swing
- 770 mm chuck to table
- MT2



**NOVA
Viking 16" DVR Drill Press**

Part No. **TK-VIKING**

- 750 W (1 HP) direct drive motor
- 150-6000 rpm variable speed
- 406 mm swing
- 265 mm chuck to table
- MT2



Schools switch options are available. Please contact us for further information.

* Carbatec supplied machinery meet all applicable Australian standards. Please confirm that individual specifications meet relevant State or Territory specific school OHS Requirements.





carbatec

CARBATEC
400 mm Variable Speed Scroll
Saw with Rotary Tool
Part No. **SS-400H**

SS-400H

There's no better machine for making small or intricate projects, such as toys, puzzles, signs or ornaments, than a scroll saw! SS-400H features an integrated foot switch for hands-free switching and control. A flexible and detachable rotary tool is included to help add some personal touches to your work, sand, grind and even drill some small starter holes so you can experiment with pinhole and intricate scrolling.



Pégas®
SWISS BLADES

A comprehensive selection of scroll saw blades is available. Please contact us or visit our website for further information.

SS-530C

This Carbatec scroll saw has been at the forefront of scroll saw technology for many years. Unlike other scroll saws, this machine has a tilting upper and lower arm instead of a tilting table. The operator can retain their natural stance for greater control, accuracy and safety.



carbatec

CARBATEC
21"
Variable Speed
Scroll Saw
Part No.
SS-530C

- 150 W (1/2 HP)
- Head tilts, not the table
- Most popular size
- Steel plate 345x597 mm
- 18 mm blade stroke
- 51 mm depth of cut



LAGUNA

Cyclone Dust Extractors

The particles in a cyclonic swirl increase in velocity, creating higher CFM (Cubic Feet per Minute) and higher static pressure.

Larger and heavier particles slow down when meeting the crossbar and settle in the drum. Only the finer dust gets carried with the air stream up through the centre vane, through to the filter. All workshop air is returned filtered through the HEPA or 1 Micron canister.



- ① **L-shaped dual mount motor bracket**
Reduces vibration with oversized vertical bracket
 - ② **One-piece main plenum allows direct airflow**
Helps reduce resistance
 - ③ **Radial steel fan**
Balanced to ISO 1940 standards
 - ④ **Splitter inlet and sealed cap**
Made of rubber, not hard plastic
 - ⑤ **Filter surface area up to 120% larger than competitors**
Canister paper made in Denmark
 - ⑥ **Ingenious lift system eliminates flex hose**
Patented lift design creates strong seal
 - ⑦ **High quality swiveling casters**
4" diameter and 3" diameter drum casters
- Newly designed dual paddles**
Provides twice the cleaning



LAGUNA
P-FLUX 1 Series Cyclone Dust Extractor

Part No. **LGT-PFLUX1B**

- 1100 W (1-1/2 HP) induction motor
- 900 CFM max. airflow
- 10.1"/H2O max. static pressure
- 94 litres drum capacity
- Footprint (WxDxH): 1168x610x1753 mm



LAGUNA
C-FLUX 3 Series Cyclone Dust Extractor

Part No. **LGT-CFLUX3B**

- 2200 W (3 HP) 32 A induction motor
- 2253 CFM max. airflow
- 11.2"/H2O max. static pressure
- 174 litres drum capacity
- Footprint (WxDxH): 1420x720x2350 mm



LAGUNA
P-FLUX 3 Series Cyclone Dust Extractor

Part No. **LGT-PFLUX3B**

- 2200 W (3 HP) 32 A induction motor
- 1624 CFM max. airflow
- 11.2"/H2O max. static pressure
- 174 litres drum capacity
- Footprint (WxDxH): 1300x700x2260 mm



carbatec

CARBATEC
Pleated Filter Cartridges to suit all Carbatec dust collectors

Please contact us or visit our website for information.



triton

TRITON
Dust Collection Bucket 23 litres

Part No. **TRI-DCA300**



LAGUNA

LAGUNA
A-Flux 1/2HP Room Air Filtration Unit

Part No. **LGT-AFLUX**

Replacement filter options available. Please contact us or visit our website for further information.



carbatec

CARBATEC
1700 CFM Room Air Filter

Part No. **AF-2000C**

Also available 650 CFM Room Air Filter
Part No. **AF-1000C**

Schools switch options are available. Please contact us for further information.

* Carbatec supplied machinery meet all applicable Australian standards. Please confirm that individual specifications meet relevant State or Territory specific school OHS Requirements.



carbatec

**CARBATEC
In-Line Cyclone
Dust Collector**

Part No. **CDC-INLINE-02**

- Unpowered unit connects to your existing dust collector or dust system
- Sits between your powered collector and your machines
- Footprint (W×D×H): 640×760×1480 mm

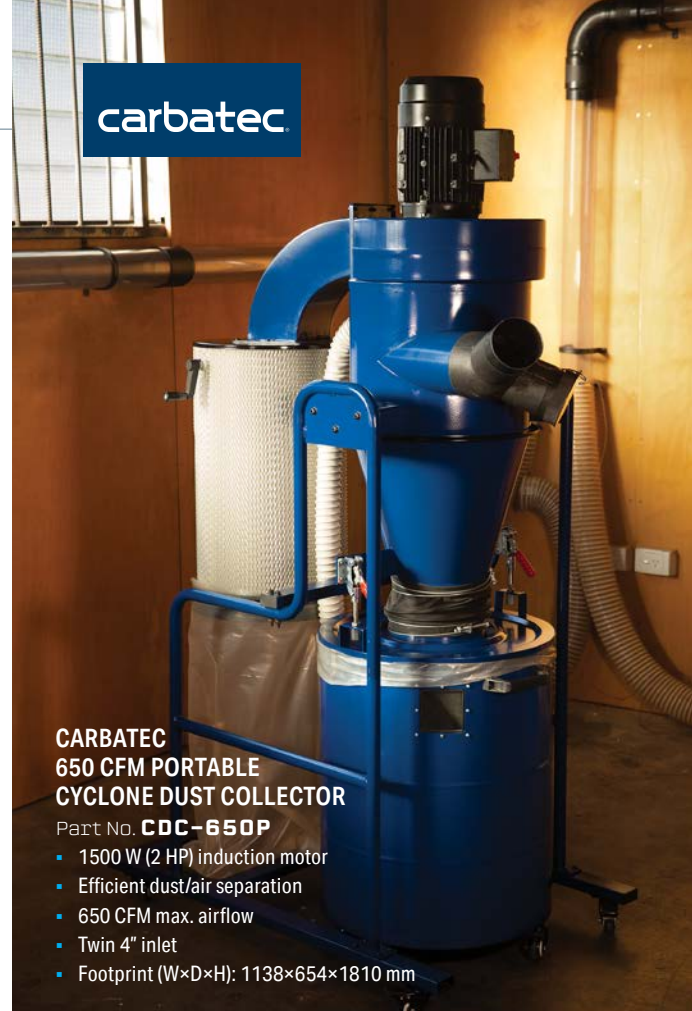

carbatec

**CARBATEC
650 CFM PORTABLE
CYCLONE DUST COLLECTOR**

Part No. **CDC-650P**

- 1500 W (2 HP) induction motor
- Efficient dust/air separation
- 650 CFM max. airflow
- Twin 4" inlet
- Footprint (W×D×H): 1138×654×1810 mm

carbatec

**CARBATEC
1200 CFM Portable Dust Collector**

Part No. **DC-1200P**

- 1500 W (2 HP) induction motor
- 1200 CFM max. airflow
- Twin 4" inlet
- Footprint (W×D×H): 560×850×1950 mm



**CARBATEC
500 CFM Under Bench Dust Collector**

Part No. **DC-F500H**

- 750 W (1 HP) induction motor
- Can be wall mounted
- Optional cartridge filter available
- 500 CFM max. airflow
- Single 4" inlet
- Footprint (W×D×H): 450×1200×390 mm

Why a dust-collector?

A clean, dust-free work place is not only safer, but far less work in the long run. There is less clean-up and less airborne dust, which is very important when it comes to the finishing stage and your health. Carbatec offer many options in dust collection from small units designed for single machines to large units capable of connection to multiple machines.

carbatec

**CARBATEC
850 CFM Portable
Cyclone Dust Collector**

Part No. **CDC-850P**

- 1500 W (2 HP) induction motor
- Efficient dust/air separation
- 850 CFM max. airflow
- Triple 4" inlet
- Footprint (W×D×H): 660×1200×1750 mm



carbatec



A comprehensive range of hose, collection bags and dust fittings are available. Please contact us or visit our website for further information.

carbatec

**CARBATEC
Professional Twin Bag
Dust Collector**

Part No. **DC-2300P**

- 2100 W (2-3/4 HP) induction motor
- Massive dust holding capacity
- 1800 CFM max. airflow
- Triple 4" inlet
- Footprint (W×D×H): 1550×750×2220 mm





Build your project
with the I2R automated technology.



**I2R A Series
CNC A24 Machine 610 x 1220 mm**

Accessories not included.
Part No. **I2R-A24**



**I2R A Series
CNC A23 Machine 610 x 915 mm**

Accessories not included.
Part No. **I2R-A23**



**I2R A Series
CNC A22 Machine 610 x 610 mm**

Accessories not included.
Part No. **I2R-A22**



**I2R A Series Stand
Suits A24 CNC Machine 610 x 1220 mm**

PC and accessories not included.
Part No. **I2R-AS800**



**I2R A Series Stand
Suits A23 CNC Machine 610 x 915 mm**

PC and accessories not included.
Part No. **I2R-AS600**



**I2R A Series Stand
Suits A22 CNC Machine 610 x 610 mm**

PC and accessories not included.
Part No. **I2R-AS400**



I2R Safety Enclosure for A Series

Available in 3 sizes

Part No. **I2R-SAFETY-A22**

Part No. **I2R-SAFETY-A23**

Part No. **I2R-SAFETY-A24**



These enclosures are custom-designed and manufactured in Australia, specifically for schools and other institutions that require the highest level of safety and regulatory compliance.

Schools switch options are available. Please contact us for further information.

** Carbatec supplied Machinery meet all applicable Australian Standards. Please confirm that individual specifications meet relevant State or Territory specific school OHS Requirements.*



I2R
Magnetic Dust Shoe
for i2R A/B Series CNC
Part No. **I2R-ADS221**



I2R
CNC Hold Down Clamps
Part No. **I2R-I2RHC1**



I2R
Professional Tool Box
Part No. **I2R-TB005**



I2R
Rotary 4th Axis Expansion Kit
Part No. **I2R-RK360**

Vectric

PASSIONATE ABOUT CNC

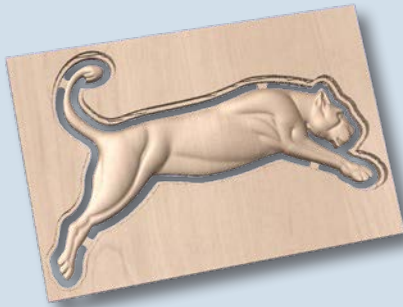

Photo VCarve by Vectric
Part No.
VEC-PHOTOVCARVE



Aspire by Vectric
Part No.
VEC-ASPIRE



Carve Pro by Vectric
Part No.
VEC-VCARVEPRO

CNC SOFTWARE



SPEKTRA
EXTREME TOOL LIFE COATING

UPTO
2.5X
LONGER LIFE
COMPARED TO UNCOATED BITS

CNC ROUTER BITS



AMANA TOOLS
AMS-188-K 4 Piece CNC Spektra Bit Set
1/4" Shank
Part No. **AM-AMS-188-K**



AMANA TOOLS
AMS-254-K 3 Piece CNC Spektra Bit Set
1/4" Shank
Part No. **AM-AMS-254-K**



AMANA TOOLS
AMS-177-K 8 Piece Deluxe CNC Bit Collection
1/4" Shank
Part No. **AM-AMS-177-K**



LAGUNA
Revo 12/16 Midi Lathe CE Model*

Part No. **LGT-REVO-1216**

- 750 W (1 HP) induction motor
- 50-3000 rpm variable speed
- 24 position indexing
- 640 mm between centres
- 405 mm swing over capacity
- Footprint (W×D×H): 750×226×442 mm (without stand)



LAGUNA
Revo 18/36 Lathe CE Model*

Part No. **LGT-REVO-1836**

- 1500 W (2 HP) induction motor
- 50-3500 rpm variable speed
- 14/36/48 position indexing
- 910 mm between centres
- 450 mm swing over capacity
- Footprint (W×D×H): 1524×660×1194 mm



LAGUNA
Revo 24/36 Lathe CE Model

Part No. **LGT-REVO-2436**

- 2200 W (3 HP) induction motor
- 50-3500 rpm variable speed
- 14/36/48 position indexing
- 910 mm between centres
- 610 mm swing over capacity
- Footprint (W×D×H): 1524×660×1270 mm



NOVA
Comet II DR Midi Lathe EVS with Digital Readout

Part No. **TK-COMET-DR**

- 550 W (3/4 HP) brushed motor
- 240-4000 rpm variable speed
- 12 position indexing
- 419 mm between centres
- 300 mm swing over capacity
- Footprint (W×D×H): 850×300×420 mm



NOVA
Orion 18"x 22" DVR Lathe

Part No. **TK-ORION**

- 1500 W (2 HP) direct drive motor
- 100-5000 rpm variable speed
- 24 position indexing
- 578 mm between centres
- 457 mm swing over capacity
- Footprint (W×D×H): 1130×597×1245 mm

Woodturning is having a massive resurgence in popularity. Your project can be started and completed in a day with only a few basic tools and a lathe, available in a variety of sizes and configurations.

Mini Lathes are usually designed to be light enough to be moved onto a workbench and stored away when not being used. When choosing your mini lathe, consider its 'swing-over' capacity, and the maximum length between the head and tail stocks. This will dictate the maximum length of your completed project. It's a great start on your journey to learn to turn, with models available for just a few hundred dollars.

Midi lathes offer some extra 'swing-over' capacity and extra power. They can also be a full featured, full-size lathe, with a modified and shortened bed, giving you a compact footprint but more versatile machine. It's a great upgrade up from a mini lathe, where your skills are growing, but your workshop space isn't.

Full-sized lathes are for many turners the first and the last lathe they ever buy. Where space permits, a full-sized lathe is just as capable at small, intricate project work as it is at creating a four-poster bed. The widest choice of features, drive types, power etc. Many have outboard turning capabilities, to allow turning pieces of a very large diameter. Higher power for great control and quicker work.

Schools switch options are available - please contact us for further information.

*Carbatec supplied Machinery meet all applicable Australian Standards. Please confirm that individual specifications meet relevant State or Territory specific school OHS Requirements.

carbatec



**CARBATEC
Benchtop Lathe**

Part No. **WL-B1220H**

- 925 W input / 750 W (1 HP) universal motor
- 300-3500 rpm variable speed with digital readout
- 535 mm between centres
- 305 mm swing over capacity
- Footprint (W×D×H): 1030×310×410 mm



**CARBATEC
Benchtop Lathe**

Part No. **WL-B1420P**

- 1 HP induction motor with delta VFD (Variable Frequency Drive)
- 50-3200 rpm variable speed with digital readout
- 510 mm between centres
- 355 mm swing over capacity
- Footprint (W×D×H): 1090×410×480 mm



**CARBATEC
Economy 900 mm
Variable Speed Wood Lathe**

Part No. **WL-900H**

- 560 W (3/4 HP) induction motor
- 500-2000 rpm variable speed
- 840 mm between centres
- 300 mm swing over capacity
- Footprint (W×D×H): 1600×400×1120 mm



**CARBATEC
Economy 1100 mm
Variable Speed Wood Lathe**

Part No. **WL-1100P**

- 1100 W (1-1/2 HP) induction motor
- 500-2000 rpm variable speed
- 1130 mm between centres
- 410 mm swing over capacity
- Footprint (W×D×H): 2000×450×1200 mm



**CARBATEC
Electronic Variable Speed
Compact Floor Lathe**

Part No. **WL-1324P**

- 750 W (1 HP) Servo induction motor with VFD (inverter)
- 100-3250 rpm variable speed
- 540 mm between centres
- 328 mm swing over capacity
- Footprint (W×D×H): 1290×580×1090 mm



**CARBATEC
Deluxe Electronic Variable Speed
Floor Model Lathe**

Part No. **WL-1624P**

- 1500 W (2 HP) induction motor with Delta VFD (inverter)
- 100-3000 rpm over two belt ranges
- 560 mm between centres
- 408 mm swing over capacity
- Footprint (W×D×H): 1570×580×1230 mm

Robert Sorby

Enormous range of individual chisels available at carbatec.com.au



ROBERT SORBY
67HS Woodturning Starter Set
Part No. **RSB-A67HS6T**



ROBERT SORBY
5 Piece Turning Tool Set
in a Leather Roll
Part No. **RSB-A5HS5TLR**



ROBERT SORBY
5 Piece Turning Tool Set
Part No. **RSB-A52HS5T**



ROBERT SORBY
Pen Turning Set
Part No. **RSB-A36HS3T**

carbatec



CARBATEC
Economy Turning Chisel Set
6 pce
Part No. **TJ-6C**



CARBATEC
Economy Miniature
Turning Chisel Set - 3 pce
Part No. **TJ-3**



CARBATEC
Heavy Duty Dual-Bearing
Live Centre #2 MT
Part No. **MCL-202N**



CARBATEC
Spur Drive 4 Prong #2 MT
Part No. **MCL-222N**



CARBATEC
Centre Finder - Plastic
Part No. **CENTRE-FIND**



CARBATEC
Multi-Spur Drive Centre
#2MT
Part No. **DC-0200**



SOBA
7 Piece
Centre Punch Set
Part No. **CT-180900**



nova™



NOVA
SN2 Pro-Tek Chuck
Part No. **TK-SN2-PT**



NOVA
G3 Pro-Tek Chuck
Part No. **TK-G3-PT**

*Chucks require an insert.
A range of inserts to suit most lathes are available separately. Please contact us.*



NOVA
Centre System
Part No. **TK-CENTRE**



NOVA
10 in 1 Chuck Gauge
Part No. **TK-10051**

carbatec



CARBATEC
3 Piece Tungsten Carbide
Deep Swan Neck Hollowing
Woodturning Chisel Set
Part No. **CT-WTC-CHTS3**



CARBATEC
3 Piece Cryogenic M2 HSS
Medium Woodturning Chisel Set
Part No. **CT-WTC-3S-CRYO**



CARBATEC
3 Piece Tungsten Carbide
and Stainless Steel
Small/Medium Scraper Set
Part No. **CT-WTC-RCT3**



CARBATEC
6 Piece Cryogenic M2 HSS
Medium Woodturning Chisel Set
Part No. **CT-WTC-6S-CRYO**



CARBATEC
4 Piece Tungsten Carbide
and Stainless Steel
Medium/Large Scraper Set
Part No. **CT-WTC-RCT4**



CARBATEC
6 Piece Cryogenic M2 HSS
Large Woodturning Chisel Set
Part No. **CT-WTC-6CT-CRYO**

NEW!

Introducing the new range of individual chisels! Featuring the same high quality Cryogenic M2 HSS, with 63-65 Rockwell lasting 2-3x longer than regular M2 HSS, these chisels offer a way to expand your turning capacity.



CARBATEC
Cryogenic M2 HSS 2.3 mm
Euro Parting Tool
Part No. **CT-WTC-PT-32**



CARBATEC
Cryogenic M2 HSS 38 mm
Bowl Scraper
Part No. **CT-WTC-BS-38**



CARBATEC
Cryogenic M2 HSS 38 mm
Round Nose Scraper
Part No. **CT-WTC-RNS-38**



CARBATEC
Cryogenic M2 HSS
French Curve Negative Cut Scraper
Part No. **CT-WTC-AS-2040**



CARBATEC
Cryogenic M2 HSS 16 mm
Bowl Gouge
Part No. **CT-WTC-BG-16**
Also available in 12 mm.



CARBATEC
Cryogenic M2 HSS 16 mm
Spindle Gouge
Part No. **CT-WTC-SG-16**
Also available in 6.35 mm.



CARBATEC
Cryogenic M2 HSS 40 mm
Roughing Gouge
Part No. **CT-WTC-RG-40**



HERMES Sandpaper Sheets

Available in:
60, 80, 120, 150, 180, 240, 320 & 400 grit
Part No. **SS-240**



HERMES Wet & Dry Sandpaper Sheets

Available in:
600, 800, 1000, 1200, 1500 & 2000 grit
Part No. **WD-1200**



CARBATEC 20 Pce Drum Sanding Set 2 1/2" Long

Part No. **DRUM-20L**
Replacement Sleeves for DRUM-20L Set:
Part No. **DRUM-20LS**



CARBATEC Drum Sanding Spindle Set with Sanding Sleeves

Part No. **CT-DS-4PCE**
Replacement Sleeves 80 grit:
Part No. **CT-DS-80G**
Replacement Sleeves 120 grit:
Part No. **CT-DS-120G**



NEW!



3M XtractTM 150 mm Sanding Disc Project Pack

Part No. **3M-A-X150-PP**
Includes two sheets each of 80, 120, 180, 220, 240 & 320 grit.
Also available in 80, 120, 180, 240 & 320 grit



CARBATEC Belt/Disc Cleaning Stick - Large

Part No. **BELT-CLEANER-L**
Also available in medium size.



Hermes Sandpaper Wraps and Rolls for Wide Drum Sanders

WIDE DRUM SANDERS



PRE-CUT WRAPS



25 METER ROLLS



carbatec
WDS-4080P

LAGUNA

LGT- WDS-1632

WDS-SP-40
WDS-SP-80
WDS-SP-120
WDS-SP-180
WDS-SP-MIX*

-

LAGUNA

LGT-WDS-1938

CT-WDSP1938-60
CT-WDSP1938-80
CT-WDSP1938-120
CT-WDSP1938-180
CT-WDSP1938-MIX*

carbatec
WDS-630C

LAGUNA

LGT-WDS-2550

MS-SP-60
MS-SP-80
MS-SP-120
MS-SP-MIX*
* Mix packs include 1 x 80G wrap and 1 x 120G wrap

SPR-3-60-25
SPR-3-80-25
SPR-3-120-25
SPR-3-180-25
SPR-3-240-25

SPR-4-60-25
SPR-4-80-25
SPR-4-120-25
SPR-4-180-25
SPR-4-240-25



A comprehensive range of sandpaper sizes and grits is available. Contact us or visit our website for more information.



CARBATEC 5pce Sandpaper Strips
Part No. **CT-SPS-5**



CARBATEC 5 Pce Mesh Sanding Kit
Part No. **CT-SMS-5**

KUSTOM CREATIONS Kustom Blu-Sheen Wet Sanding Solution
Part No. **KM-BLU**





BOW PRODUCTS
Products GuidePro Bandsaw Guide
Part No. **BOW-GP5**



CARBATEC
BOW-PP1
Part No. **PS-20**



CARBATEC
Push Block & Stick Pack - 5 piece
Part No. **CT-PBK-5PCE**



BOW PRODUCTS
PushPro Push Stick
Part No. **BOW-PP1**



CARBATEC
Push Blocks - Pair
Part No. **PB-1**



CARBATEC
Twin Featherboard Set
Part No. **CT-FB-2PCE**



HEDGEHOG
Spiral Featherboard
Part No. **HH-100**
Also available: Large Stacking Accessory
Part No. **HH-30**



KREG
Single Featherboard
Part No. **KR-PRS3010**



BOW PRODUCTS
FeatherPro Featherboard
Part No. **BOW-FP1**



BOW PRODUCTS
FeatherDuo
Dual Featherboard Stack
Part No. **BOW-FP3**



BOW PRODUCTS
FencePro Featherboard
Part No. **BOW-FP4**



KREG
Twin Featherboards
Part No. **KR-PRS3020**



MAGSWITCH
Universal Featherboard
Part No. **MAG-0015**



ARCHER
Leather Shop Apron
Part No. **AR-1783**



CARBATEC
Canvas Apron
Part No. **67K10-06**



RESPIRATORY PROTECTION
EYE PROTECTION
HEARING PROTECTION

3M SECURE-CLICK™ REUSABLE HALF FACE MASKS



All the best
3M™ safety solutions
are available at

carbatec®
THE HOME OF WOODWORKING

3M GOGGLEGEAR 500 SERIES SAFETY GLASSES



3M OPTIME II DELUXE LOW PROFILE EARMUFFS



More 3M safety solutions at carbatec.com.au

	Quick Latch 6500QL Series HALF-FACE MASKS	<ul style="list-style-type: none"> Quick Latch mechanism allows you to quickly drop down your mask when out of the contamination area. 3M™ Cool Flow™ valve makes breathing easier while reducing heat or moisture build-up. Exhalation valve directs exhaled breath downward Filter solutions available for all wood working needs including nuisance level organic vapor or gas. Also available: kits including mask and extra cartridges or filters 	3M-6501QL	small
	Secure Click HALF-FACE MASKS	<ul style="list-style-type: none"> Allows easier communication with mask on Push button seal check Speaking diaphragm Secure click connection Low profile, wide view and high compatibility Also available: kits including mask and extra cartridges or filters 	3M-HF-801SD	small
	Asbestos/Dust 6000 Series FULL-FACE MASK KITS	<ul style="list-style-type: none"> Large lens provides a wide field of view Lightweight Silicone face seal for comfort and ease of cleaning Centre adapter directs exhaled breath downward Includes full-face mask, filters, wipes, earplugs, guide and container 	3M-HF-802SD	medium
	E. A. R Ultrafit EARPLUGS	<ul style="list-style-type: none"> Reusable triple flange design Available in cases for hygienic and safe storage Push to fit style for easy and hygienic fit Available in box of 50 	3M-HF-802SD	large
	No Touch EARPLUGS	<ul style="list-style-type: none"> Easy to use, no need to roll the foam before fitting Convenient stem for quick and hygienic insertion Tapered shape fits the ear canal comfortably Available in box of 100 	3M-6835S	small
	Optime I Low Profile EARMUFFS	<ul style="list-style-type: none"> Reduce noise levels up to 28 dB Combines easily with other safety equipment, lightweight Large space inside the cups helps minimise heat & moisture build-up Soft, wide cushions reduce pressure around the ears 	3M-6835M	medium
	Optime II Deluxe Low Profile EARMUFFS	<ul style="list-style-type: none"> Reduce noise levels up to 32 dB High level hearing protection that muffles even extremely low frequencies Large space inside the cups helps minimise heat & moisture build-up Soft, wide cushions reduce pressure around the ears 	3M-6835L	large
	Blue BROW GUARD VISOR & CHIN GUARD	<ul style="list-style-type: none"> Low to high impact protection Ratchet adjustable headband Friction pivoting system for lifting and lowering 	3M-340-4001	uncorded
	Gogglegear 500 Series SAFETY GLASSES	<ul style="list-style-type: none"> Scotchgard Anti-Fog coating retains its effectiveness for at least 25 washings Low profile, clear lenses Indirect ventilation 	3M-340-4002	corded
	Secure Fit 200 & 400 Series SAFETY GLASSES	<ul style="list-style-type: none"> Self-adjusting and snug fit keeps eye wear in place 3M Pressure Diffusion Temple Technology Lightweight (less than 30 g) Anti-scratch coating 	3M-P2000	uncorded
	2700 Series Clear SAFETY GLASSES	<ul style="list-style-type: none"> For use over prescription glasses Low-profile design 	3M-P2001	corded
			3M-H510A	headband
			3M-H510B	neckband
			3M-H510F	foldable headband
			3M-H520A	headband
			3M-H520B	neckband
			3M-H520F	foldable headband
			3M-VC107	
			3M-GG501NSGAF-AS	
			3M-SF201AF-AS	Frameless
			3M-SF401AF-AS	Anti-Fog, Black & green
			3M-2700	

GLUES



TITEBOND
Original Wood Glue, 3.8 l
Part No. **TBD-1-3785ML**
Also available in 237 ml, 473 ml & 946 ml.



TITEBOND
II Premium Wood Glue, 3.8 l
Part No. **TBD-2-3785ML**
Also available in 237 ml, 473 ml & 946 ml.



TITEBOND
III Ultimate Wood Glue, 3.8 l
Part No. **TBD-3-3785ML**
Also available in 237 ml, 473 ml, & 946 ml.



TITEBOND
Liquid Hide Glue, 237 ml
Part No. **TBD-LH-237ML**



TITEBOND
Melamine Glue, 473 ml
Part No. **TBD-MM-473ML**



TITEBOND
Polyurethane Glue, 355 ml
Part No. **TBD-POL-355ML**



TITEBOND
Quick & Thick Multi-Surface Glue
Part No. **TBD-QT-237ML**



PREP
Multi-Use Adhesive, 500 ml
Part No. **PREP-MULTI-500**



ZAP
ZAP CA, Thin Viscosity, 2 oz,
Cyanoacrylate 'Super' Glue
Part No. **ZAP-THIN**



ZAP
ZAP-A-GAP, Medium Viscosity,
2 oz, Cyanoacrylate 'Super' Glue
Part No. **ZAP-MEDIUM**



ZAP
SLO-ZAP, Thick Viscosity, 2 oz,
Cyanoacrylate 'Super' Glue
Part No. **ZAP-THICK**



ZAP
ZIP KICKER, CA Accelerator, 2oz,
Cyanoacrylate 'Super' Glue
Part No. **ZAP-ACCEL**



TITEBOND
Titebrush
Part No. **TBD-TITEBRUSH**



ROCKLER
Glue Applicator Set
Part No. **RK-57361**



CARBATEC
Glue Bottle Set
Part No. **GS-114**



ROCKLER
3-Piece Silicone Glue
Application Kit
Part No. **RK-43662**



ORGANOIL
Citrus Terpene - 1 litre
Part No. **ORG-CITRUS-1LTR**



ORGANOIL
Tung Oil - 1 litre
Part No. **ORG-TUNG-1LTR**



ORGANOIL
Danish Oil - 1 litre
Part No. **ORG-DO-1LTR**



ORGANOIL
Hard Burnishing Oil - 500 ml
Part No. **ORG-HB-500ML**



ORGANOIL
Wax & Polish - 500 ml
Part No. **ORG-WP-500**



U-BEAUT
Food Safe Mineral Oil
Part No. **UB-FS**



U-BEAUT
Shellawax Glow - 500ml
Part No. **UB-SGW**



U-BEAUT
Sanding Sealer - 500 ml
Part No. **UB-SS500**



U-BEAUT
EEE Ultra Shine
Part No. **UB-EEE**



KUSTOM CREATIONS
Kustom Rotary Polish
Step 1 and Step 2 Set
Part No. **KM-ROT-SET**



KUSTOM CREATIONS
Kustom Wax Beeswax
Paste and Liquid Set
Part No. **KM-BEESWAX-SET**



KUSTOM CREATIONS
Kustom High Speed Polish
Step 1 and 2 Small Kit
Part No. **KM-HSP-SET**



WHITTLE WAXES
Evolution Matte Hardwax Oil - 0.5l
Part No. **WW-TEM30279**



WHITTLE WAXES
Satin Hardwax Oil - 0.5l
Part No. **WW-TES30285**



WHITTLE WAXES
Hardwax Oil, Evolution Classic - 0.5l
Part No. **WW-TEC30282**



WHITTLE WAXES
Gloss Hardwax Oil - 0.5l
Part No. **WW-TEG30288**



**CARBATEC
Continuous Sweeping
Clock Movement
14 mm Shaft**

Part No. **CLK-CS14**

Also available in:

11 mm: Part No. **CLK-CS11**

7 mm: Part No. **CLK-CS7**

A comprehensive range of clock hands and numbers is available. Please contact us or visit our website for more information.

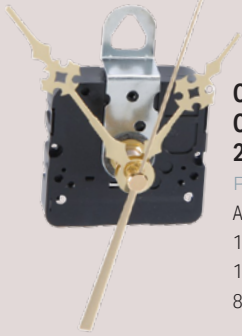

**CARBATEC
Clock Movement
24 mm Shaft**

Part No. **CLK-7290**

Also available in:

17 mm: Part No. **CLK-7260**

11 mm: Part No. **CLK-7190**

8 mm: Part No. **CLK-7160**



**CARBATEC
Lazy Susan Bearings**

Available in several sizes:

L-33: 3"

L-88: 8"

L-44: 4"

L-99: 9"

L-66: 6"

L-120: 12"



**CARBATEC
Ball Point Pen Parts Gold Finish
with Black Clip - Pack of 5**

Part No. **PEN-1**

Also available with gold clip:

Part No. **PEN-1V**



**CARBATEC
Pen Refill - Blue**

Part No. **REFILL BLUE**

Also available:

Part No. **REFILL BLACK**



**CARBATEC
Pen Mill (Unhandled) for 7 mm Pens**

Part No. **PEN-MILL**



**CARBATEC
Pen Mandrel #2MT**

Part No. **MAND-92**



**CARBATEC
Assorted Tasmanian Timber
Pen Blanks Pack of 5**

Part No. **WPP-TAS1**



**CARBATEC
Jacobs Style Chuck
13 mm / #2MT**

Part No. **HM-6**

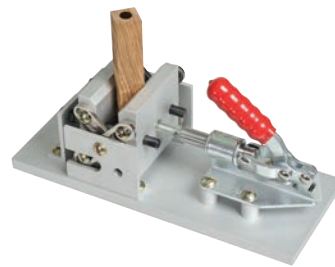

**CARBATEC
Quick Action Self-Centring
Pen Blank Drilling Jig**

Part No. **CT-PV4**

A comprehensive range of pen parts and pen blanks is available in timber or resin. Please contact us or visit our website for more information.



**CARBATEC
Deluxe Pen Assembly Press**

Part No. **CT-PAP3**



**CARBATEC
Long Series Brad Point Bit
7 mm - HSS**

Part No. **BPD-8MM-PRC**

Also available in 8mm, 10 mm, 3/8" and 27/64"





EYE CANDY
Hue Series Box Set
Part No.
ECC-02003



EYE CANDY
Colour Shift Box Set
Part No.
ECC-02023



EYE CANDY
Neon Series Box Set
Part No.
ECC-02025



EYE CANDY
River Ocean Box Set
Part No.
ECC-08001-05



EYE CANDY
Glow in the Dark Box Set
Part No.
ECC-02027-05

A comprehensive range of individual coloured pigments is also available. Please contact us or visit our website for more information.



KUSTOM CREATIONS
Kustom Grit Superfine and Microfine Grit
Step 1 and Step 2 Set
Part No. **KM-GRIT-SET**



ATL
Perfect Cast 2 Part Resin & Hardener
Deep- 15 litre kit
Part No. **ATL-DEEP-E**
Available in 750 ml, 1.5 litre, 3.5 litre, 6 litre, 30 litre



ATL
Perfect Cast 2 Part Resin & Hardener
Rigid - 15 litre kit
Part No. **ATL-RIGID-E**
Available in 750 ml, 1.5 litre, 3.5 litre, 6 litre, 30 litre



Robert Sorby

ROBERT SORBY
Peter Child Artist's
Pyrography Machine

Part No. **RSB-PYR02400**



FLEXCUT
KN50 Sloyd Knife

Part No. **FLX-KN-50**



FLEXCUT
Flexible Drawknife

Part No. **FLX-KN-16**



FLEXCUT
3 Knife Starter Set

Part No. **FLX-KN-500**



FLEXCUT
KN52 Single Bevel
Sloyd Hook Knife

Part No. **FLX-KN-52**



FLEXCUT
6 Piece Mallet Starter Set

Part No. **FLX-MC-150**



FLEXCUT
Beginner Palm & Knife Set

Part No. **FLX-KN-600**

A comprehensive range of individual woodcarving chisels is available.
Please contact us or visit our website for more information.



FLEXCUT
Knife Strop

Part No. **FLX-PW-14**



FLEXCUT
Gold Compound

Part No. **FLX-PW-11**



FLEXCUT
Slipstrop Kit

Part No. **FLX-PW-12**



FLEXCUT
Carving Knife Set

Part No. **FLX-KN-100**

NEW!

RAMIA[®] WORKBENCH

Ramia workbenches beat building your own! They are faster, cost-effective, and come in a variety of options. Made with solid Birch wood, they are easy to assemble and boast beautiful finishes. Find them at Carbatec along with cabinets and accessories.



**SCHOOL
PREFERRED**



NEW!

RAMIA[®] WORKBENCH

RAMIA Quad Teaching Workbench - SCHOOL Series

Part No. **RM-SCH-X**

- 4 vices (190 mm capacity)
- 40 mm thick worktop
- Pre-drilled bench dog holes for each vice
- Shared tool well in the centre
- 8 round bench dogs included

RM-SCH-X

This 1200 mm square worktop is great for introducing students to woodworking. The timber-jawed, metal woodworking vices are robust enough for new woodworkers but won't damage their work. Sturdy timber legs provide a stable base for this workbench. Optional adjustable steel legs and locking storage cupboards are also available.

Shown with optional adjustable steel legs

Part No. **RM-STEEL**



Shown with optional locking cabinet

Part No. **RM-SCH-XZ**

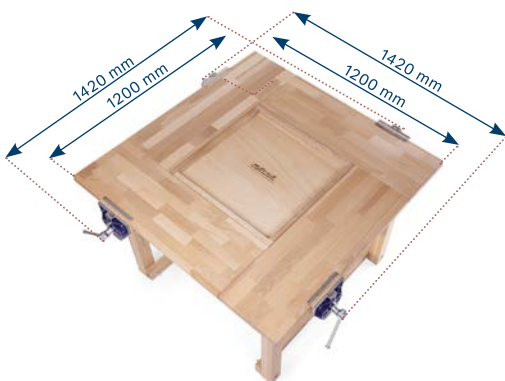



RM-PRO-ASM1700
 Designed for the exacting woodworker, this premium workbench features two traditional vices (front and tail) and a 50 mm worktop. Weighing in at 90kg, this bench provides a stable platform for your most demanding projects.

NEW!

**RAMIA
 Premium Monster 1700 Workbench -
 PRO Series**

Part No. **RM-PRO-ASM1700**

- Front vice: 190 mm capacity
- Tail vice: 145 mm capacity
- 50 mm thick worktop with pre-drilled bench dog holes
- Tool well at rear of worktop
- Storage drawer
- Shared tool well in the centre
- 4 PRO Series round bench dogs included

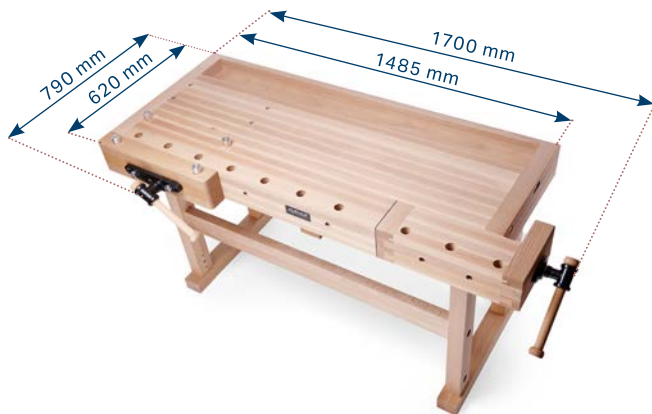

NEW!

**RAMIA
 Storage Cabinet
 PRO Series**

Part No. **RM-PRO-II**

- Twin door cabinet with middle shelf
- Four drawers (390 x 365 mm)
- Compatible with Premium Plus 1600 Workbench (RM-PRO-AS1600)
- Compatible with Premium Monster 1700 Workbench (RM-PRO-ASM1700)

RM-PRO-II
 Fits most Ramia PRO series workbenches. It is composed of a twin-door cupboard with a middle shelf next to four drawers. It conveniently stores your frequently used tools away from dust and shavings while adding weight to your workbench.





RAMIA
WORKBENCH

NEW!

**RAMIA
Diamond 1800 Workbench -
HOBBY Series**

Part No. **RM-HB-D1800**

- Two 130 mm capacity front/side mount vices with flexible mounting options
- 30 mm thick worktop with pre-drilled bench dog holes
- Tool well at rear of worktop
- Storage shelf
- Shared tool well in the centre
- 4 round bench dogs included

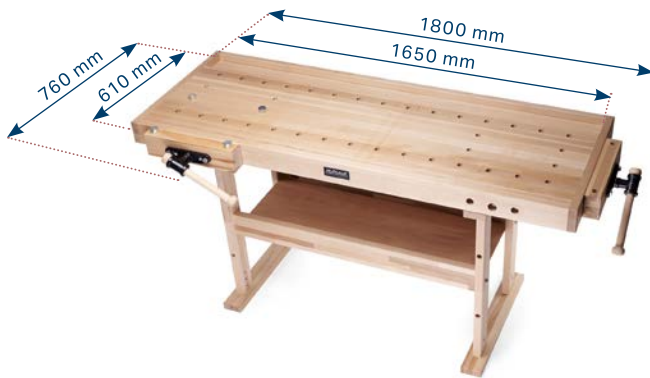

Shown with optional locking cabinet

Part No. **RM-HB-II**



RM-HB-D1800

A versatile workbench at a reasonable price. It comes with two traditional front woodworking vices and has four mounting locations, so the vices can be mounted to suit your workshop needs and personal preference. The worktop has two rows of pre-drilled dog holes, a tool storage shelf and features a tool well in the back.



RAMIA
WORKBENCH

NEW!

**RAMIA
Storage Cabinet
HOBBY Series**

Part No. **RM-HB-II**

- Twin door cabinet with middle shelf
- Four drawers (390 x 365 mm)
- Compatible with Diamond 1800 Workbench (RM-HB-D1800)



Tools not included

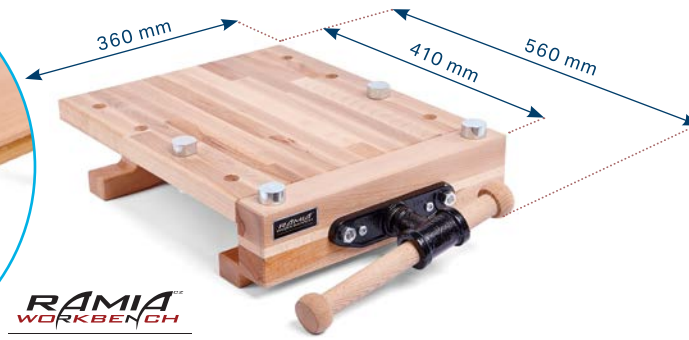

NEW!

**RAMIA
Portable Worktop - HOBBY Series**

Part No. **RM-HB-CW**

- 1 front vice with double guide rods
- Vice capacity: 130 mm
- Pre-drilled bench dog holes
- Portable and easy to secure
- 4 round steel bench dogs included



NEW!

**RAMIA
Portable Workbench
HOBBY Series**

Part No. **RM-HB-FF**

- 1 vice
- Single 130 mm capacity front vice with left or right-hand installation option
- 30 mm thick worktop with pre-drilled bench dog holes
- Easy to assemble and disassemble yet stable enough for demanding projects
- 4 round bench dogs included

**RAMIA
WORKBENCH**

RM-HB-FF

This workbench is remarkably stable for such a portable and convenient platform. The 30 mm worktop securely fastens to the support legs providing a sturdy platform for your latest project. Dog holes and a front vice offer quick, convenient clamping. When your project is complete, this bench quickly disassembles and can be stored out of the way.

At a glance

SCHOOL SERIES

Product name	Quad Teaching Workbench	Square Teaching Workbench	Dual-Sided Workbench	Adjustable Steel Legs for 4-Station Workbench	Storage Cabinet
Product code	RM-SCH-X	RM-SQUARE	RM-GOAL	RM-SCH-STEEL	RM-SCH-XZ
Core range/Special order	Core Range	Special Order	Special Order	Core Range	Special Order
Number of vices	4	4	4	0	0
Vice type	Quick release	Front vices	Front & side vices	—	—
Working width (mm)	1200	1380	1250	—	—
Overall width (mm)	1420	1850	1540	970	850
Working depth (mm)	1200	1380	850	970	—
Overall depth (mm)	1420	1850	1140	—	425
Worktop height (mm)	840	840	850	910	500
Weight (kg)	96	112	74	22	31
Compatible with	RM-SCH-XZ RM-SCH-STEEL	RM-SCH-XZ RM-SCH-STEEL	—	RM-SCH-X RM-SQUARE	RM-SCH-X RM-SQUARE



At a glance



PROFESSIONAL SERIES								
Product name	Premium Superb Workbench		Premium Monster Workbench		Premium Plus Workbench		Storage Cabinet	
Product code	RM-PRO-APS		RM-PRO-ASM		RM-PRO-AS		RM-PRO	RM-PRO
	1700	2100	1700	2100	1600	2100	II	III
Core range/Special order	Special Order	Special Order	Core Range	Special Order	Core Range	Special Order	Core Range	Special Order
Number of vices	2		2		2		0	0
Vice	FRONT: Twin Screw TAIL: Double guide rail		FRONT: Traditional TAIL: Traditional		FRONT: Traditional TAIL: Traditional		—	—
Working width (mm)	1515	1910	1485	1910	1440	1920	—	—
Overall width (mm)	1745	2165	1700	2120	1640	2120	1195	1195
Working depth (mm)	615	615	620	620	620	620	—	—
Overall depth (mm)	830	830	790	790	790	790	480	565
Worktop height (mm)	870	870	870	870	870	870	460	450
Weight (kg)	124	141	90	97	76	91	40	45
Compatible with	RM-PRO-II	—	RM-PRO-II & III	—	RM-PRO-II & III	—	RM-PRO-AS1600 & ASM1700	RM-PRO-AS1600 & ASM1700

HOBBY SERIES				
Product name	Diamond Workbench	Portable Workbench	Portable Worktop	Storage Cabinet
Product code	RM-HB-D1800	RM-HB-FF	RM-HB-CW	RM-HB-II
Core range/Special order	Core Range	Core Range	Core Range	Core Range
Number of vices	2	1	1	0
Vice type	Front vice	Front vice	Front vice	—
Working width (mm)	1650	1350	410	—
Overall width (mm)	1800	1350	560	1000
Working depth (mm)	610	500	360	—
Overall depth (mm)	760	650	360	430
Worktop height (mm)	850	850	—	500
Weight (kg)	53	36	10	30
Compatible with	RM-HB-II	—	—	RM-HB-D1800

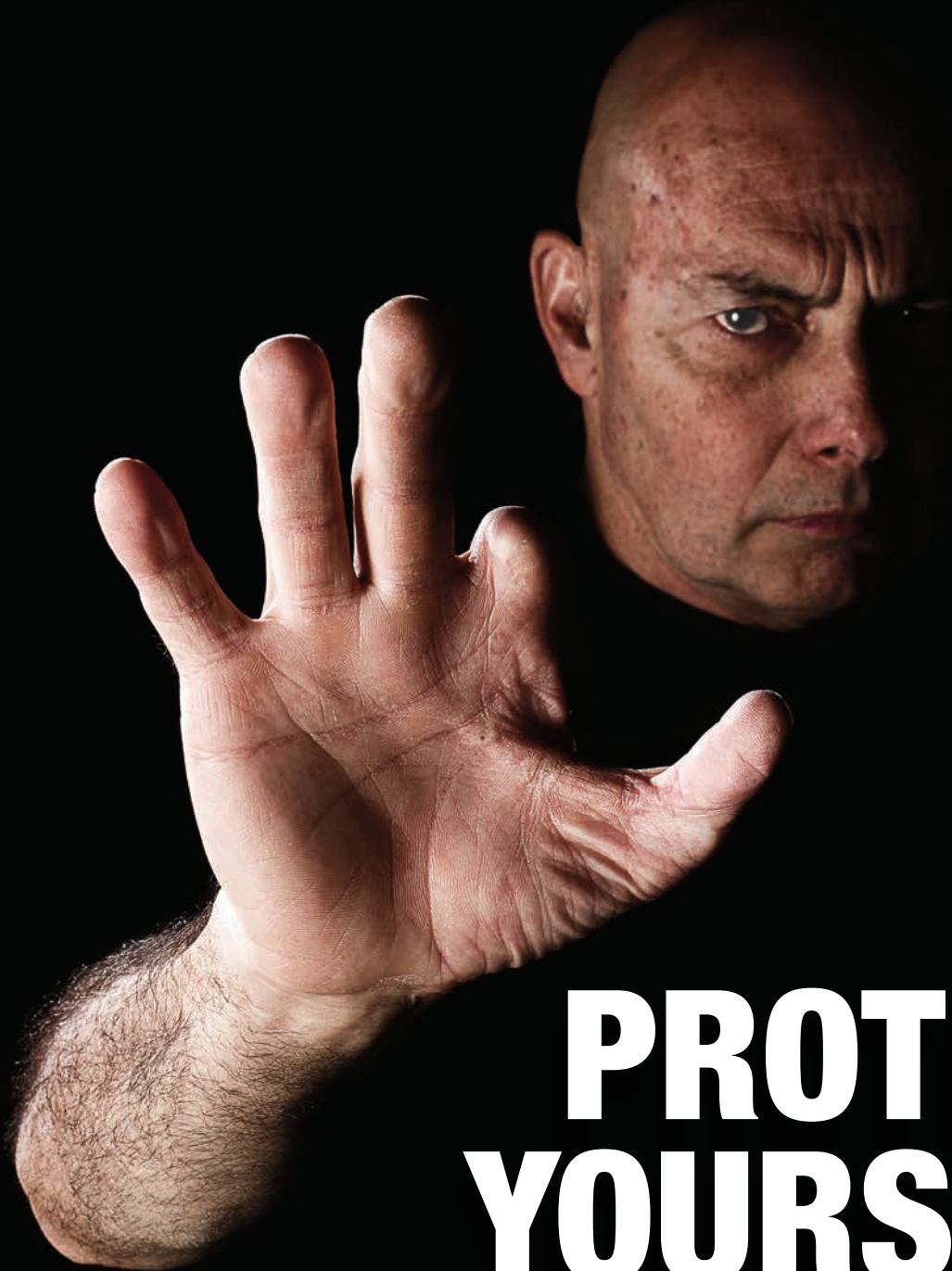

PROTECT YOURSELF



THE WORLD'S SAFEST TABLE SAW

THE TABLE SAW IS THE MOST DANGEROUS TOOL IN YOUR SHED.

SawStop table saws stop on contact with skin. With 15 years of industry-leading quality and thousands of fingers saved, it's easy to see why SawStop is the #1 cabinet saw across North America and is growing fast in Australia.

Visit our knowledgeable team in store or call 1800 658 111

carbatec
THE HOME OF WOODWORKING

ADELAIDE
27 MAGILL RD
STEPNEY
SA 5069

BRISBANE
128 INGLESTON RD
WAKERLEY
QLD 4154

HOBART
17 FARLEY ST
GLENORCHY
TAS 7010

MELBOURNE
80-82 OSBORNE AVE
SPRINGVALE
VIC 3171

PERTH
1/168 BALCATT A RD
BALCATT A
WA 6021

SYDNEY
113 STATION RD
AUBURN
NSW 2144

AUCKLAND
110 HARRIS RD
EAST TAMAKI
AKL 2013

CHRISTCHURCH
67 STURROCKS RD
CASEBROOK
CHC 8051

CARBATEC.COM.AU