

PRICE
SHAVINGS

JUNE 2015

carbatec®
THE HOME OF WOODWORKING

INTRODUCING ...

THE WORLD'S
SAFEST TABLESAW



| www.carbatec.com.au

In this Issue...



SawStop

THE
WORLD'S
SAFEST
TABLESAW



GET INTO PEN
TURNING



NOVA INFINITY
CHUCK

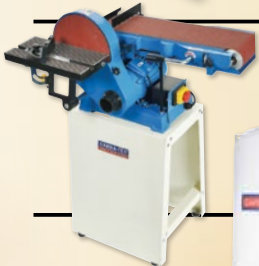

SANDING



DUST CONTROL
/ SAFETY



KREG®



TORMEK®
LIMITED OFFER



DRILLING



WORKSHOP
ACCESSORIES

SMALL BUSINESS TAX DEDUCTIONS



Buy up to \$20,000
per asset before 30th
June 2015 and claim in
this year's Tax Return!*

*You should seek professional advice to determine whether you are able to claim a deduction for such purchases made. For more information visit www.ato.gov.au

SEE CARBATEC AT ONE OF THE 2015 EVENTS & SHOWS

PERTH WOOD SHOW

CLAREMONT, PERTH
7TH-9TH AUGUST

TIMBER & WORKING WITH WOOD SHOWS

Mini Retail Store, Live Machine Shop,
Product & Skill Demonstrations

SYDNEY

12TH - 14TH JUNE

Sydney Showground at Olympic Park,
Sydney NSW

MELBOURNE

23RD - 25TH OCTOBER

Melbourne Convention & Exhibition Centre,
Melbourne VIC

ROBERT SORBY AUSTRALIAN TOUR

Carbatec will again host Chris Pouncy on a Tour of Australia demonstrating Robert Sorby Woodturning Tools. This year's Tour will visit southern regional centres & all major cities. See website for details www.carbatec.com.au/events.

DATES: 13TH JULY - 3RD AUGUST

SAWSTOP IN-STORE LIVE DEMOS

Carbatec will be running live SawStop Demonstrations in-store during June. See www.carbatec.com.au for details.

SEE THE WORLD'S SAFEST TABLESAW AT THE SYDNEY AND MELBOURNE SHOWS



WOODWORKING DEMONSTRATIONS

Every second Saturday, selected Carbatec stores hold in-store demonstrations.

Check our website for details of our June/July demonstrations including:

- School Holiday Kids Program - Basic Toys
- Dressing Timber using Planer Jointers & Thicknessers
- Focus on Faux Finishes
- DIY Router Table
- Spooncarving
- Wooden Surfboard Making
- Handcarving
- Pen Turning - from turning to assembly
- Hands-on Handtools - set-up & use

Check our website for full event details

Follow. Share. Stay in touch online...

www.carbatec.com.au



carbatec
THE HOME OF WOODWORKING



SAWSTOP'S PATENTED SAFETY SYSTEM
Stops The Saw Blade On Contact With Skin

THE WORLD'S SAFEST TABLESAW



CONTRACTOR SAW

1.75 HP 1PH 240V 10A

Cabinet footprint	655mm (w) x 686mm (d)
Cast table dimension	510mm (w) x 686mm (d)
With extension wings	1120mm (w) x 686mm (d) <i>optional*</i>
Table in front / behind blade	270mm / 180mm
Weight (sawbody only)	103kg
Blade Guard	Micro Blade Guard
Dust Collection	Below-table dust shroud & 4" dust port
Lock-out & Interrupt switches	None
Saw and Motor Warranty	1 year

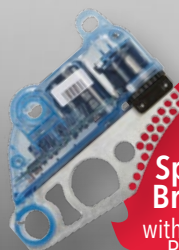

FREE!
Spare Standard Brake Cartridge
with every Saw, Fence & Rail pack purchase
INTRODUCTORY OFFER
JUNE ONLY

OPTIONAL EXTRAS:



Dust Collection Blade Guard
SS-TSG-DC **\$249**

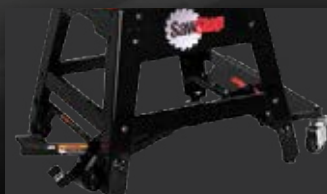

Contractor Saw Mobile Base
SS-MB-CNS-000 **\$199**



4" / 2.5" Dust Collection Panel
SS-CNS-DCP **\$99**



*Cast Iron Wing Assembly (Pair)
SS-CNS-CIWA **\$299**

Overarm Dust Collection & much more...
ON PAGE 7

CHOOSE A FENCE AND RAIL TO COMPLETE YOUR SAW



CONTRACTOR SAW & 36" T-GLIDE FENCE & RAIL

SS-CNS175-AU (SAWBODY)	\$2,250
SS-PCS-FENCE36 (FENCE+RAIL)	\$440
Overall Footprint: 1760mm (w) x 1145mm (d) x 885mm (h)	
TOTAL PRICE (All items sold separately)	\$2,690

CONTRACTOR SAW & 52" T-GLIDE FENCE & RAIL

SS-CNS175-AU (SAWBODY)	\$2,250
SS-PCS-FENCE52 (FENCE+RAIL)	\$640
Overall Footprint: 2165mm (w) x 1145mm (d) x 885mm (h)	
TOTAL PRICE (All items sold separately)	\$2,890



PROFESSIONAL CABINET SAW

3.0 HP 1PH 240V 15A

Cabinet footprint	495mm (w) x 495mm (d)
Table dimension	510mm (w) x 686mm (d)
With extension wings	1120mm (w) x 686mm (d)
Table in front / behind blade	260mm / 190mm
Weight (sawbody only)	152kg
Blade Guard	Dust Collection Blade Guard
Dust Collection	Advanced below-table dust shroud
Lock-out & Interrupt switches	None
Saw and Motor Warranty	2 years

FREE!
Spare Standard Brake Cartridge
with every Saw, Fence & Rail pack purchase
INTRODUCTORY OFFER
JUNE ONLY

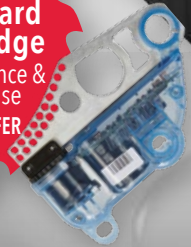

OPTIONAL EXTRAS:



Professional Integrated Mobile Base
SS-PCS-MB **\$259**



Industrial Mobile Base (w/ adapter for Professional Cabinet Saw)
SS-PCS-MBIND **\$439**

Sliding Crosscut Table & much more...
ON NEXT PAGE

CHOOSE A FENCE AND RAIL TO COMPLETE YOUR SAW

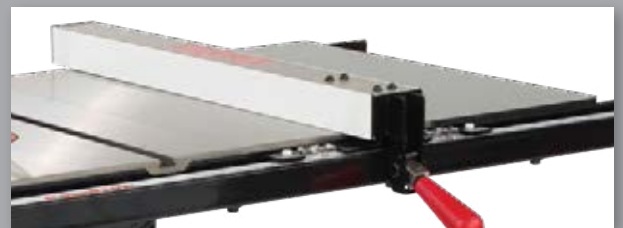

PROFESSIONAL CABINET SAW & 30" PREMIUM FENCE & RAIL

SS-PCS-31230 (SAWBODY)	\$3,959
SS-PCS-FENCE30 (FENCE+RAIL)	\$340
Overall Footprint: 1570mm (w) x 790mm (d) x 865mm (h)	

TOTAL PRICE (All items sold separately) **\$4,290**



PROFESSIONAL CABINET SAW & 36" T-GLIDE FENCE & RAIL

SS-PCS-31230 (SAWBODY)	\$3,959
SS-PCS-FENCE36 (FENCE+RAIL)	\$440
Overall Footprint: 1760mm (w) x 840mm (d) x 865mm (h)	

TOTAL PRICE (All items sold separately) **\$4,399**

PROFESSIONAL CABINET SAW & 52" T-GLIDE FENCE & RAIL

SS-PCS-31230 (SAWBODY)	\$3,959
SS-PCS-FENCE52 (FENCE+RAIL)	\$640
Overall Footprint: 2165mm (w) x 840mm (d) x 865mm (h)	

TOTAL PRICE (All items sold separately) **\$4,599**



The Industrial difference:

The Industrial Cabinet Saw is engineered for heavy duty cycle environments. It comprises a thicker cast iron table for added stability and precision as well as thicker gauge steel in the cabinet, rails, tube and fence, compared to the Contractor and Professional models. Larger hand wheels for easy adjustment and two large access doors for quick access and maintenance are also some of the additional features.



INDUSTRIAL CABINET SAW

3.0 HP 1PH 240V 15A

Cabinet footprint	510mm (w) x 635mm (d)
Table dimension	610mm (w) x 765mm (d)
With extension wings	1120mm (w) x 765mm (d)
Table in front / behind blade	280mm / 250mm
Weight (sawbody only)	241kg
Blade Guard	Dust Collection Blade Guard
Dust Collection	Advanced below-table dust shroud
Lock-out & Interrupt switches	On all access doors - disable saw when open
Warranty	Motor: 5 years Saw Body: 2 years

FREE!
Spare Standard Brake Cartridge
 with every Saw, Fence & Rail pack purchase
 INTRODUCTORY OFFER
 JUNE ONLY

OPTIONAL EXTRAS:



Industrial Cabinet Saw
 Mobile Base
 SS-ICS-MB **\$399**

Three quick pumps of foot pedal raises saw

Four 360° casters move in any direction



Hydraulic piston assists lift

CHOOSE A FENCE AND RAIL TO COMPLETE YOUR SAW



INDUSTRIAL CABINET SAW & 36" T-GLIDE FENCE & RAIL

SS-ICS-31240 (SAWBODY) **\$4,399**
 SS-ICS-FENCE36 (FENCE+RAIL) **\$600**
 Fence/Rail Size: 1760mm (w) x 930mm (d) x 865mm (h)
TOTAL PRICE (All items sold separately) **\$4,999**

INDUSTRIAL CABINET SAW & 52" T-GLIDE FENCE & RAIL

SS-ICS-31240 (SAWBODY) **\$4,399**
 SS-ICS-FENCE52 (FENCE+RAIL) **\$800**
 Fence/Rail Size: 2165mm (w) x 930mm (d) x 865mm (h)
TOTAL PRICE (All items sold separately) **\$5,199**

SEE THE NEXT PAGE FOR Overarm Dust Collection & much more...

Stops On Contact With Skin



On contact, an electrical signal on the blade changes because the human body is conductive. The saw detects that change.

A spring pushes a brake into the blade, stopping the blade in milliseconds.

Force from the stop drops the blade below the table. The saw shuts off the motor.

Watch The Video
Learn how it works!
SawStop.com/demo



Compatible with all SawStop saws. Fits all SawStop rail and table lengths.
(For Contractor Saw: Requires Dust Collection Panel and Dust Collection Blade Guard)

OVERARM DUST COLLECTION

SS-ODC **\$339**



Engineered to fit your SawStop table saw, with pre-drilled mounting holes. Black-anodized T-6 aircraft-grade aluminium. Delivers easy, repeatable, accurate results.

SLIDING CROSSCUT TABLE

SS-TSA-SA48 **\$1,799**



30" Outfeed Table
SS-OFT-30 **\$199**



Phenolic Lock Down Inserts
Standard & Dado (zero clearance)
SS-INSERT-STD **\$64**
SS-INSERT-DADO **\$64**



Brake Cartridges
Standard & Dado
SS-BRAKE-STD **\$99**
SS-BRAKE-DADO **\$139**

COMMON SAW FEATURES:

- SawStop's Patented Safety System
- Tool-Free Blade Guard Change
- Hands-Free Shut-Off
- Massive 62mm Arbor Bearing
- Riving Knife
- Left Tilt Blade



Get into PEN TURNING

Turning pens continues to increase in popularity. It is easily accessible in skill level and affordability while being a great introduction to woodturning.

Learn more at one of our in-store Pen Turning demonstrations in June.

(Details at: www.carbatec.com.au/events)

A PEN TURNING TOOLKIT...

THE LATHE

A mini/midi lathe is perfect such as:

- Carbatec Economy Mini Lathe
- Jet Mini Lathe
- Woodfast Mini Lathe
- Teknatool Nova Comet II Midi Lathe

A MANDREL

- Allows you to turn a pen between centres without risk of interference

SELF-CENTRING PEN VICE

- Allows you to locate and drill the exact centres of your pen

PEN MILL

- Essential to get the perfect alignment of parts for a perfect finish

PEN KITS

- A range styles and finishes are available including Twist or Click Ball Point or Fountain Style Pens and Pencil in Gold, Silver, Titanium, Platinum finishes

PEN BLANKS

- Wooden and Acrylic Blanks available

BUSHES

- Check your kit for requirements

PEN PRESS

- A perfect helper when wanting to press components together

MICROMESH OR CLOTH BACKED SANDPAPER

- To sand and provide a brilliant shine before coating with your preferred finish

PEN MAKING PACK OFFER:

Buy as a pack and save \$20

PEN VISE (CT-PV4)

PEN PRESS (CT-PAP1)

MANDREL NO. 2 (MAND-92)

PEN MILL (PEN-MILL)

CLOTH BACKED SANDING KIT

(SPS95-01) (See page 11)

PEN-STARTKIT

ONLY \$175



TEKNATOOL® NOVA COMET II MIDI LATHE (TK-COMET)

Portable, space saving - yet delivers the capacity and the rugged stability of larger lathes. Perfect for a wide range of Woodworking projects.

TEKNATOOL® G3 REVERSIBLE CHUCK (TK-48232)

TK-COMET-PACK **PACK OFFER \$824**

SAVE
OVER
\$185

PACK OFFER



PEN DRILLING JIG

Automatic size adjustment.

PV-609 **ONLY \$120**



QUICK ACTION SELF-CENTERING PEN DRILLING JIG

Includes quick action clamp.

CT-PV4 **ONLY \$59**



#2 MT PEN MANDREL SAVER PACKAGE

Includes a dedicated mandrel, 7mm drill bit, 3 bushings, Mandrel Saver Tailstock Center (no threads or knurled nut).

PKMS2SET **ONLY \$50**



PEN PRESS

- Up to 130kg pressure
- Clamps easily to a bench
- Fits any pen kit

CT-PAP1 **ONLY \$63**



PEN MILL - UNHANDLED

- Trims and squares wood and brass tubes
- For perfect pen part alignment

PEN-MILL **ONLY \$27**



1/4" MORSE TAPER PEN MANDREL SET

Either mandrel can be unscrewed from the Morse taper and used in a drill chuck if preferred.

MANDREL - NO. 1 MT

MAND-91

MANDREL - NO. 2 MT

MAND-92

ONLY \$17 EACH

'Price Shavings' are available online, by phone on 1800 658 111 and in participating stores: Brisbane, Sydney, Melbourne, Adelaide, & Launceston.



**CARBATEC®
ECONOMY
MINI LATHE**

MC1018

**ONLY
\$359**

- 5 Speeds 500 – 3200 rpm
- Cast Iron
- Max distance between centres: 440mm
- ½ HP 240v Motor
- Hole through Tailstock: 10mm
- Morse Taper: MT2



**JET MINI
LATHE**

JET-JML1014I

**ONLY
\$529**

- 6 Speeds 400 – 3300rpm
- Cast Iron
- Max distance between centres: 350mm
- ½ HP 230v Motor
- Hole through Tailstock: 9mm
- Morse Taper: MT2



**MONT BLANC STYLE -
PLATINUM
PEN PARTS - 5 PACK**

BT-401P Reg. \$47 **ON SALE \$38**



**COMFORT RHODIUM
PEN PARTS - 5 PACK**

PEN-8RH Reg. \$38 **ON SALE \$27**



**TYCOON
RHODIUM
ROLLERBALL
PEN PARTS
1 PACK**

PEN-6RHR
Reg. \$27

CLEARANCE* **ON SALE \$22**



acrylic
Pen Blanks

carbatec.com.au

For our full range visit us in-store or online



**MICRO-MESH™
FINISHING PACK**

SP-MMESH-SET

ONLY \$18

- Fine MicroMesh Pattern produces high gloss on wood and acrylics
- Cloth backed sanding product
- Foam layer increasing control
- Perfect for Pen Blanks



**TITEBOND®
ORIGINAL
WOODGLUE
3.785 LITRE**

TBD-1-3785ML-PK

ONLY \$32

**FREE
GLUE
BRUSH**



**TITEBOND® II
PREMIUM
WOODGLUE
3.785 LITRE**

TBD-2-3785ML-PK

ONLY \$35

**FREE
GLUE
BRUSH**



**TITEBOND® III
ULTIMATE
WOODGLUE
3.785 LITRE**

TBD-3-3785ML-PK

ONLY \$40

**FREE
GLUE
BRUSH**

SIGN UP TO OUR MAILING LIST to receive monthly specials, event and demonstration invitations and articles.

Follow. Share. Stay in touch online...

www.carbatec.com.au



carbatec
THE HOME OF WOODWORKING



NOVA INFINITY UPGRADE SLIDE SET

TK-8100 Reg. \$149

ON SALE \$134

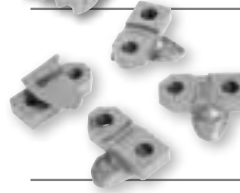

NOVA INFINITY RETRO KIT

TK-8200 Reg. \$55

ON SALE \$49



NOVA INFINITY SAW TOOTH JAW #2

Standard Equipment:
4 x Infinity Bowl Saw Tooth Jaws #2

1 x Instruction Manual

TK-8312 Reg. \$109

ON SALE \$99



NOVA INFINITY BOWL JAW #1

Standard Equipment:
4 x Infinity Bowl Jaws #1

1 x Instruction Manual

TK-8301 Reg. \$89

ON SALE \$79

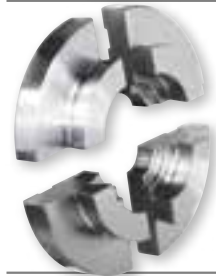

NOVA INFINITY BOWL JAW #2

Standard Equipment:
4 x Infinity Bowl Jaws #2

1 x Instruction Manual

TK-8302 Reg. \$99

ON SALE \$89



NOVA INFINITY BOWL JAW #3

Standard Equipment:
4 x Infinity Bowl Jaws #3

1 x Instruction Manual

TK-8303 Reg. \$95

ON SALE \$84



NOVA INFINITY SMOOTH COLUMN JAW #1

Provides a seamless and secure workholding range for positive holding.

TK-8321 Reg. \$95

ON SALE \$84



NOVA INFINITY SAW TOOTH JAW #1

Standard Equipment:
4 x Infinity Saw Tooth Jaws #1

1 x Instruction Manual

TK-8311 Reg. \$95

ON SALE \$84

How much wood could a woodchuck turn if a woodchuck used the new Nova Infinity Chuck from Teknatool?

The Nova Infinity Chuck system changes the game in Wood Lathe Chucks with unparalleled benefits to wood chuck users...

TK-8012 Reg. \$349

ON SALE \$329



ALREADY OWN A NOVA CHUCK...

WHY UPGRADE TO THE INFINITY CHUCK?

- Change out and mount jaws simply and easily
- Don't limit yourself by constraints of conventional jaws - choose the jaw that best fits your work
- With the Nova Upgrade and Retro fit-ability - reap the benefits of the new Infinity Chuck but still keep and use your favourite jaws & chucks

NEW TO THE GAME...

WHY THE NOVA INFINITY CHUCK?

- The Nova Infinity Chuck can do the job of many chucks - saves money
- Change out and mount jaws in 30 secs not 8 minutes - save time
- Fit the right jaw to suit your work not the other way around - save headaches



'Price Shavings' are available online, by phone on 1800 658 111 and in participating stores: Brisbane, Sydney, Melbourne, Adelaide, & Launceston.



CARBATEC® 6"X9" BELT/DISC SANDER WITH STAND (SB-609)

Belt can be used vertically or horizontally. Disc table tilts to 45°. Standard equipment includes graphite slip cloth underneath the belt. Also fitted with quick change hook and loop 9" disc. Stand and mitre gauge included.

+ FREE LARGE BELT / DISC CLEANER (BELT-CLEANER-L)

To clean - simply hold the edge of the stick against the belt or disc face while the machine is running. SB-609-PK

PACK OFFER \$399

Reduce the need to buy expensive sleeves. Simply wrap sheet sandpaper around the drum.

THE SET CONTAINS:

1" x 3", 2 1/2" x 3", 2" x 3", 3" x 3" drums. 2 x 1/2" and 2 x 1/4" drive shafts, a quantity of spare paper, cam key (Allen key not included).

SLEEVELESS DRUM & SANDING SET

DRUM-SET-4 Reg. \$90

ON SALE \$78

SINGLE DRUM SIZES AVAILABLE:

SANDING DRUM 1" X 3"

DRUM-1 Reg. \$19

ON SALE \$16

SANDING DRUM 2" X 3"

DRUM-2 Reg. \$21

ON SALE \$16

SANDING DRUM 2-1/2" X 3"

DRUM-2-1/2 Reg. \$23

ON SALE \$17

SANDING DRUM 3" X 3"

DRUM-3 Reg. \$26

ON SALE \$19



CLOTH BACKED SANDING KIT

An ideal accessory for woodturning spindle work, pen making and other applications where narrow sanding strips are an advantage. This kit contains four rolls of 25mm x 6 metre sanding lengths with the following grits: 150, 240, 320 and 400.

SPS95-01 Reg. \$29

ON SALE \$20



20 PIECE MID LENGTH SANDING SET (BOXED)

Includes four drums with diameter of 1/2", 3/4", 1" and 1-1/2" (each 2" in length). Also includes additional sleeves.

DRUM-SET-20 Reg. \$32

ON SALE \$25



20 PIECE LONG SERIES SANDING SET

Includes: 1/2", 3/4", 1" and 1-1/2" diameter spindles. All spindles are 2-1/2" long. Two 80 and 120 grit sanding sleeves are included for each drum.

DRUM-20L Reg. \$32

ON SALE \$25

SIGN UP TO OUR MAILING LIST to receive monthly specials, event and demonstration invitations and articles.

Follow. Share. Stay in touch online...

www.carbatec.com.au



carbatec
THE HOME OF WOODWORKING



An excellent value for money machine. Suited for the hobbyist or weekend woodworker's workshop. Effective for removal of chips and shavings from one machine at a time. Fitted to a castor base for ease of mobility around your workshop.

CARBATEC® 1HP ECONOMY DUST EXTRACTOR

FM-230-PK

SPECIAL OFFER \$269



The ideal choice for the larger garage or shed workshop. The additional power in this machine means that you can have up to 2 machines connected at the same time. Perfect for planers and jointers as the volume of airflow and bag capacity are greater.

CARBATEC® 2HP ECONOMY DUST EXTRACTOR

FM-300-PK

SPECIAL OFFER \$369



Follow "Dusty" for great dust control advice, safety tips or just to shoot the breeze...

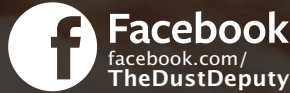

PROFESSIONAL FACE SHIELD

This face shield provides excellent protection, exceptionally comfortable and easily adjusts for fit and shield angle. The frame wraps around to protect the chin and forehead plus features a cushioned adjustable headband with washable brow pad. The tough polycarbonate shield has a scratch-resistant anti-static and anti-fog coating.

22R72-60 Reg. \$88

ON SALE \$72



POWERED DUST MASK

This powered dust mask removes the majority of minute wood dust and composite particles down to as small as 0.4 microns. Face cup is made from soft silicon for enhanced wearer comfort. Continuous run time on 4 x AA batteries approximately 6 to 10 hours. Includes 3 particulate filter cartridges and 10 pre-filter pads.

SA-201 Reg. \$119

ON SALE \$105



TREND® PRO RESPIRATOR LIGHTWEIGHT BATTERY POWERED AIRSHIELD

Air Purifying Respirator providing all-in-one respiratory protection against dust, fumes and particulates, combined with eye and face protection against impact and liquid splash. Features include:

- Low noise fan motor provides initial rate airflow of 210lpm (150lpm minimum at end of battery life)
- Audible low battery alarm
- Light weight (950g)
- Polycarbonate face-shield with nylon elasticated face seal - tinted and clear overlays available
- Air flow indicator pre-checks battery and filter performance and condition

TREND-PRO Reg. \$637

ON SALE \$617

RESPIRATOR MASK -12 PACK

P2 respirator masks with exhalation valve. Dual headstrap for optimum fit.

80PC321 Reg. \$32

ON SALE \$28



'Price Shavings' are available online, by phone on 1800 658 111 and in participating stores: Brisbane, Sydney, Melbourne, Adelaide, & Launceston.

THE ULTIMATE POCKETHOLE JOINERY SYSTEM



KREG® K4 MASTER SYSTEM

Great choice for any woodworking enthusiast. This jig truly has it all with:

- Front-side clamping capabilities
- Dust-collection attachment
- Material support stop
- Removable 3-Hole Drill Guide
- Removable drill guide for use with bench top and portable bases
- 1/8" incremental settings for materials from 1/2" to 1-1/2" thick, seemingly endless adjustability

KR-K4MS **ONLY \$220**

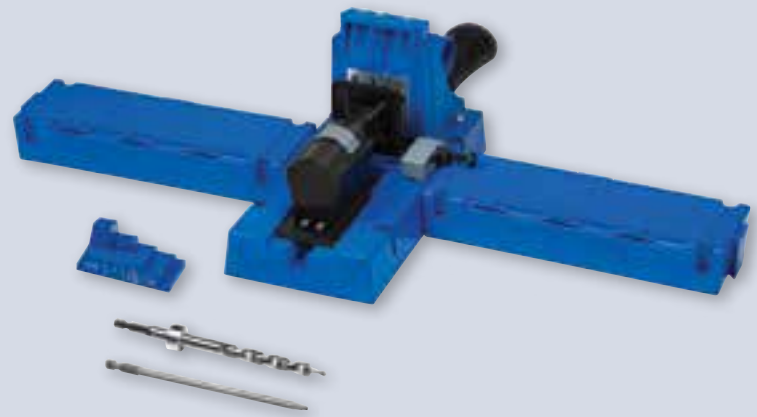

KREG® K5 POCKETHOLE JIG

The Kreg Jig® K5 incorporates the best features of every Kreg Jig® that came before it.

- Clamping mechanism adjustable without tools to match your workpiece thickness
- Large support wings to hold work steady
- Storage compartments inside supports
- Standard swiveling
- Dust collection port
- Spring-loaded stop for the drill guide block

KR-K5 **ONLY \$220**



KREG® K4 POCKET HOLE JIG

The perfect choice for DIY'ers and anyone new to Pocket-Screw Joinery. The Kreg Jig® can help you finish jobs in less time, and with far less effort than you ever thought possible.

- Removable Drill Guide for benchtop and mobile use
- 1/8" incremental settings for materials from 1/2" to 1-1/2" thick.
- Patented 3 drill guide fixed spacing on the Drill Guide

KR-K4 **ONLY \$154**



KREG® POCKET HOLE SCREW KIT

- Kreg pocket hole screws feature a self-tapping auger point eliminating the need to pre-drill your work
- Kit contains 5 of the most popular self-tapping screw sizes for pocket hole joinery
- Total of 675 screws in a convenient storage case.

KR-SK03 **ONLY \$54**



KREG® SCREW SELECTOR WHEEL

Dial in the thickness of each piece to be joined—and the Wheel shows you the correct screw length and Kreg Jig® setting.

- Works with 1/2", 5/8", 3/4", 7/8", 1", 1 1/8", 1 1/4", 1 3/8", 1 1/2" material
- Compatible with Kreg Jig® K3, K4, K4MS, K5, and R3

KR-SSW **ONLY \$13**



SIGN UP TO OUR MAILING LIST to receive monthly specials, event and demonstration invitations and articles.

Follow. Share. Stay in touch online...

www.carbatec.com.au



carbatec
THE HOME OF WOODWORKING

TORMEK®

T-7

LIMITED OFFER!

LED LAMP + TORMEK HAT!

Buy your Tormek T-7 between June 1 & June 30 2015, and get this LED lamp which fits on top of your machine, plus the Tormek Hat!



LED LAMP WITH HIGH POWERED MAGNET

**TORMEK T-7
THE ULTIMATE
SHARPENING
SYSTEM**



ACCESSORIES INCLUDED:



Led Lamp & Hat Offer is by redemption through Tormek when registering your T-7 machine. A brochure with the full offer details are available from Carbatec stores at the point of purchasing your T-7. Offer valid on T-7 machines purchased between 1st June – 30th June 2015 only.

**See
In-store For
Details**



**FREE!
8 Piece CMT
Brad Point
Wood Drill Set
VALUED AT \$28**

With the Carbatec® ¼HP 16 Speed Bench Drill Press

DP-4116B-PK
Reg. \$497

ONLY \$469

CMT Brad Point Wood Drill 8 Pce Set (517-002-00)

Bits in this set range in size from 3mm to 10mm.

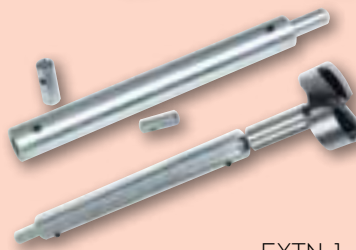

EXTN-1

Extends bits by 160mm. Suits Forstner style bits with 8mm, 5/16", 3/8" and 10mm shanks.

**FREE!
Forstner
Bit Extension**

VALUED AT \$22

With any of the following bit sets



16 PIECE SAW TOOTH BIT SET

METRIC:
Include bits of following sizes (accurate to +/-0.5mm): 6, 10, 12, 16, 20, 22, 25, 28, 32, 35, 38, 41, 45, 48, 51 and 54mm.

STB-16PCE-M-PK Reg. \$101

ONLY \$79

IMPERIAL:
Contains 1/4" to 7/8" bits in 1/8" increments. plus 1" to 2 1/8" saw tooth bits in 1/8" increments.

STB-16PCE-PK Reg. \$101

ONLY \$79

16 PIECE FORSTNER BIT SET

METRIC:
Sets include bits of following sizes (accurate to +/- 0.5mm): 6, 10, 13, 16, 19, 22, 25, 28, 32, 35, 38, 41, 44, 48, 51 and 54mm.

FSB-16PCE-M-PK Reg. \$101

ONLY \$79

IMPERIAL:
Include bits from 1/4" to 7/8" in 1/8" increments plus 1" to 2-1/8" bits in 1/8" increments.

FSB-16PCE-PK Reg. \$97

ONLY \$75

'Price Shavings' are available online, by phone on 1800 658 111 and in participating stores: Brisbane, Sydney, Melbourne, Adelaide, & Launceston.



MAGNETIC TOOL HOLDER

24" (600mm) in length. One of the most useful workshop accessories we've ever found. Courier or pick up only. Tools not included.

ES-10024 REG. \$38 **ONE FOR \$27**
 ES-10024-2PK REG. \$76 **TWO FOR \$49**



SMALL STACKABLE UTILITY BOX

High quality utility box - inside dimensions are 330 x 240 x 95mm with 6 removable and rearrangeable compartments

CT-3086C Reg. \$22

ON SALE \$15

SAVE \$7



LARGE STACKABLE UTILITY BOX

High quality utility box - inside dimensions 440 x 320 x 95mm with removable and rearrangeable compartments.

CT-3086B Reg. \$35

ON SALE \$25

SAVE \$10



MULTI-TOOL WITH LEATHER POUCH

A great gift idea.

LMT-1 Reg. \$33

ON SALE \$18

SAVE \$15



MAGNETIC PARTS TRAY

MPT-3609-2PK Reg. \$58

2 FOR \$34

SAVE \$24



CREUSEN GRINDER

CG-DS7150TS

ON SALE \$199

LIMITED STOCK

CLEARANCE*

SAVE \$14

Designed with cross-back shoulder straps to prevent neck strain, our apron is made from 100% cotton canvas, a washable material that is lightweight yet strong. At about 34" long by 28" wide, it provides ample side and front coverage, and fully adjustable.

CARBATEC® CANVAS APRON

67K10-06 Reg. \$62

ON SALE \$48



SIGN UP TO OUR MAILING LIST to receive monthly specials, event and demonstration invitations and articles.

Follow. Share. Stay in touch online...

www.carbatec.com.au



carbatec
THE HOME OF WOODWORKING

3 EASY WAYS TO SHOP WITH CARBATEC

ONLINE

www.carbatec.com.au

PHONE

1800 658 111

IN-STORE

Store Locations

BRISBANE

128 Ingleston Rd,
Wakerley, QLD 4154

SYDNEY

113 Station Rd,
Auburn, NSW 2144

MELBOURNE

80-82 Osborne Ave,
Springvale, VIC 3171

ADELAIDE

27 Magill Rd,
Stepney, SA 5069

LAUNCESTON

242 Hobart Rd,
Kings Meadows, TAS 7249
03 6344 9899

PERTH

168 Balcatta Rd,
Balcatta, WA 6021
1300 735 905

AUCKLAND

110 Harris Rd
East Tamaki, New Zealand
0800 444 329

PRICE SHAVINGS

'Price Shavings' are available from **1st - 30th June 2015** via our online store at www.carbatec.com.au, via phone orders by calling **1800 658 111** or at the following participating stores only:

BRISBANE, MELBOURNE, SYDNEY, ADELAIDE & LAUNCESTON.

This catalogue includes both Clearance/Runout items and Special/Discount offers.

*Products labeled as 'Clearance' are available only while stocks last - sorry no backorders. Special/Discount offers are available on back order if stock runs out during the sale period.

Errors and Omissions Excluded: Whilst we work to ensure information in this catalogue and our website is accurate and correct, occasionally, an error may occur and goods may either be incorrectly described or incorrectly priced.

Please review our policy at www.carbatec.com.au/howto

Small Business Tax Deductions - You should seek professional advice to determine whether you are able to claim a deduction for such purchases made.



PEFC™
PEFC/21-31-80

carbatec
THE HOME OF WOODWORKING

www.carbatec.com.au

