

carbatec



2YR
WARRANTY

OWNERS MANUAL

**150mm Professional Benchtop Segmented / Spiral
Head Jointer**

JN-BX150P

GENERAL SAFETY

NOTE: The **[WARNING!]** and **[CAUTION!]** symbols indicate a potentially hazardous situation which, if not avoided, COULD result in death or serious injury. READ THIS MANUAL completely before assembling and operating this machine.

[WARNING!] TO AVOID serious injury, death, or damage to the machine, please read, understand, and follow, all Safety and Operating Instructions before assembling and operating this machine. This manual is not totally comprehensive. It does not and cannot convey every possible safety and operational problem that may arise while using this machine. The manual will cover many of the basic and specific safety procedures needed in a workshop and industrial environment.

All federal and state laws, and any regulations having jurisdiction covering the safety requirements for use of this machine, take precedence over the statements in this manual. Users of this machine must adhere to all such regulations.

[WARNING!] Exposure to the dust created by power sanding, sawing, grinding, drilling and other construction activities may cause serious and permanent respiratory or other injury, including silicosis (a serious lung disease), cancer, and death. Avoid breathing the dust, and avoid prolonged contact with dust.

Some examples chemicals and toxins you could be exposed to (but not limited to) are:

- Lead from lead-based paints.
- Crystalline silica from bricks, cement and other masonry products.
- Arsenic and chromium from chemically treated timber and
- Asbestos residue from reclaimed timbers

Always operate tool in well-ventilated area and provide for proper dust removal. Use a dust collection system along with an air filtration system whenever possible. Always use properly fitting AS/NZS approved respiratory protection

appropriate for the dust exposure, and wash exposed areas with soap and water.

[WARNING!] ALWAYS wear eye protection. Any machine can throw debris into the eyes during operations, which could cause severe and permanent eye damage. Everyday eyeglasses are NOT safety glasses. ALWAYS wear Safety Goggles (that comply with applicable Australian Standards/New Zealand Standards, referred to as AS/NZS) when operating power tools.

[WARNING!] ALWAYS wear hearing protection. Hearing equipment should comply with appropriate AS/NZS.

[WARNING!] ALWAYS wear a AS/NZS approved dust mask to prevent inhaling dangerous dust or airborne particles.

ALWAYS keep the work area clean, well lit, and organized. DO NOT work in an area that has slippery floor surfaces from debris, grease, and wax.

[CAUTION!] ALWAYS unplug the machine from the electrical receptacle when making adjustments, changing parts or performing any maintenance.

AVOID ACCIDENTAL STARTING. Make sure that the power switch is in the "OFF" position before plugging in the power cord to the electrical receptacle.

[WARNING!] AVOID a dangerous working environment. DO NOT use electrical tools in a damp environment or expose them to rain or moisture.

[WARNING!] CHILDPROOF THE WORKSHOP AREA by removing switch keys, unplugging tools from the electrical receptacles, and using padlocks to lock out machinery, where applicable.

[CAUTION!] DO NOT use electrical tools in the presence of flammable liquids or gasses.

DO NOT FORCE the machine to perform an operation for which it was not designed. It will do a higher quality job, with less effort and safer, by only performing operations for which the machine was intended.

[WARNING!] DO NOT stand on a machine. Serious injury could result if it tips over or you accidentally contact any moving part.

DO NOT store anything above or near the machine.

[WARNING!] DO NOT operate any machine or tool if under the influence of drugs, alcohol, or medication.

Prior to operation EACH AND EVERY time, check for damaged parts prior to using any machine. Carefully check all guards to see that they operate properly, are not damaged, and perform their intended functions.

Check for alignment, binding or breakage of all moving parts. Any guard or other part that is damaged should be immediately repaired or replaced.

[WARNING!] Only connect a machine to a receptacle appropriate for the standard fitted plug and lead. Do NOT modify or replace a machine electrical component, with a lesser-rated or sub-standard component.

[CAUTION!] Keep visitors and children away from any machine. DO NOT permit people to be in the immediate work area, especially when the machine is operating.

KEEP protective guards in place and in working order.

[CAUTION!] MAINTAIN your balance. DO NOT extend yourself over the tool. Wear oil resistant rubber soled shoes. Keep floor clear of debris, grease, and wax.

MAINTAIN all machines with care. ALWAYS KEEP machine clean and in good working order. KEEP all blades and tool bits sharp.

NEVER leave a machine running, unattended. Turn the power switch to the OFF position. DO NOT leave the machine until it has come to a complete stop.

REMOVE ALL MAINTENANCE TOOLS from the immediate area prior to turning the machine ON.

[WARNING!] STAY ALERT, watch what you are doing, and use common sense when operating any machine. DO NOT operate any machine tool while tired or under the influence of drugs, alcohol, or medication. A moment of inattention while operating power tools may result in serious personal injury.

[WARNING!] USE ONLY recommended accessories. Use of incorrect or improper accessories could cause serious injury to the operator and cause damage to the machine. If in doubt DO NOT operate it.

THE USE of long extension cords is not recommended for 230V equipment. It is better to arrange the placement of your equipment and the installed wiring to eliminate the need for an extension cord. If an extension cord is necessary, seek qualified advice to determine the minimum gauge for the extension cord based on the length being used. The extension cord must also contain a ground wire and plug pin.

[CAUTION!] Wear proper clothing, DO NOT wear loose clothing, gloves, neckties, or jewelry. These items can get caught in the machine during operations and pull the operator into the moving parts. Users must wear a protective cover on their hair, if the hair is long, to prevent it from contacting any moving parts.

SAVE these instructions and refer to them frequently and use them to instruct other users.

NOTE: Information regarding the safe and proper operation of machinery and power tools is also available from the following source:

Safe Work Australia

www.safeworkaustralia.gov.au

GENERAL SAFETY INSTRUCTIONS

1. Serious personal injury may occur if normal safety precautions are overlooked or ignored. Accidents are frequently caused by lack of familiarity or failure to pay attention. Obtain advice from supervisor, instructor, or another qualified individual who is familiar with this machine and its operations.
2. Every work area is different. Always consider safety first, as it applies to your work area. Use this machine with respect and caution. Failure to do so could result in serious personal injury and damage to the machine.
3. To help prevent electrical shock, always follow all electrical and safety codes, including the AS/NZS Electrical Standards and the relative Workplace/Occupational Health and Safety and Regulations. All hard

wired electrical connections, repairs and wiring should be made by qualified personnel only.

4. **[WARNING!]** TO REDUCE the risk of electrical shock. DO NOT use this machine outdoors. DO NOT expose to rain. Store indoors in a dry area.
5. STOP using this machine, if at any time you experience difficulties in performing any operation.
6. Safety decals are on this machine to warn and direct you to how to protector yourself or visitors from personal injury. These decals MUST be maintained so that they are legible. REPLACE decals that are not legible.
7. DO NOT leave the unit plugged into the electrical outlet. A good work practice is to unplug the unit from the outlet when not in use and before servicing, performing maintenance tasks, or cleaning.
8. **[WARNING!]** DO NOT handle the plug or operate the machine with wet hands
9. USE only parts or accessories as described in this manual and recommended by Carbatec.
10. DO NOT pull the machine by the power cord. NEVER allow the power cord to come in contact with sharp edges, hot surfaces, oil or grease.
11. ALWAYS turn the power switch "OFF" before unplugging the machine. DO NOT unplug the machine by pulling on the power cord. ALWAYS grasp and pull by the plug end when removing from a power receptacle.
12. REPLACE any damaged cord and plug immediately. DO NOT operate with a damaged cord or plug and have it replaced by a qualified person.
13. DO NOT use machinery as a toy. DO NOT use near or around children.
14. ENSURE that the machine sits firmly before using. If the machine wobbles or is unstable, correct the problem by attaching to a bench top or suitable work platform, prior to operation.

15. This machine is designed for the processing of wood only. DO NOT use with other materials.
16. **[WARNING!]** NEVER position fingers, thumbs or any part of your body, near the cutterhead or blade.
17. Long pieces of stock should ALWAYS be supported with some type of fixture.
18. DO NOT operate machinery with dull or damaged blades.
19. MAKE CERTAIN that the machine is properly adjusted prior to use.

SPECIFIC SAFETY INSTRUCTIONS

1. DO NOT try and remove excessive amounts of wood in one single pass.
2. INSPECT all stock before beginning operations ensuring that there are no foreign objects embedded in the wood, loose knots, or knots that may become loose during operation.
3. **[WARNING!]** DO NOT attempt to remove jams until power is disconnected and all moving parts have come to a complete stop.
4. MAKE SURE that there is adequate operating space on both the in-feed and out-feed sides of the jointer before operating.
5. DO NOT attempt to joint or plane wood that is less than 250mm long, narrower than 19mm, or less than 12mm thick.
6. Ensure adequate dust extraction is connected to the jointer while it is in operation.
7. Use a pair of push blocks on your workpiece, to ensure your fingers are kept clear of cutterhead.

UNPACKING & INVENTORY

Check shipping carton and machine for damage before unpacking. Carefully remove packaging materials, parts and machine from shipping carton. Always check for and remove protective shipping materials around motors and moving parts. Lay out all parts on a clean work surface.

Remove any protective materials and coatings from all of the parts and the jointer. The protective coatings can be removed by spraying WD-40 on them and wiping it off with a soft cloth. This may need to be redone several times before all of the protective coatings are removed completely.

After cleaning, apply a good quality paste wax to any unpainted surfaces. Make sure to buff out the wax before assembly.

Compare the items to inventory figures and verify that all items are accounted for before discarding the shipping box.

NOTE: Some parts may already be installed on your machine. Go through the entire manual before calling.

If any parts are missing, do not attempt to plug in the power cord and turn "ON" the machine. The machine should only be turned "ON" after all the parts have been obtained and installed correctly.

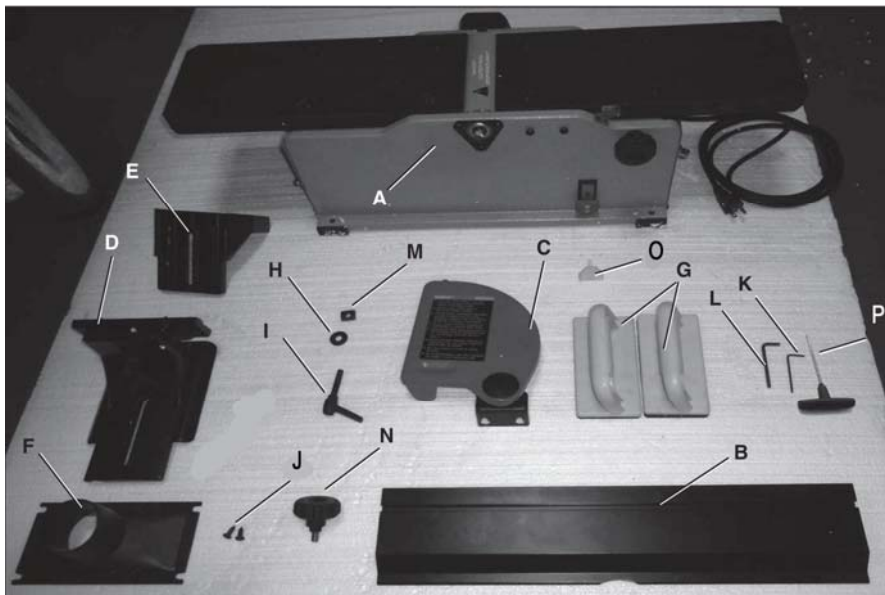

A. Jointer

B. Fence

C. Cutterhead Guard

D. Fence Sliding Bracket

E. Fence Bracket

F. Dust Port

G. Push Blocks

H. Flat Washer

I. Tilt Lock Lever Assy.

J. Soc Button head Screw

K. 2.5mm Hex Wrench

L. 4mm Hex Wrench

M. Special Nut

N. Knob

O. Switch Key

P. Torx Wrench

ASSEMBLY

WARNING! MAKE CERTAIN THAT THE MACHINE IS DISCONNECTED FROM THE POWER SOURCE.

FENCE ASSEMBLY PROCEDURE

1. Assemble the fence bracket (A) to the jointer base (B). Remove the four Soc Button Head Screws (C) on the rear frame to lock the bracket in place. SEE FIG. 1

Fig. 1

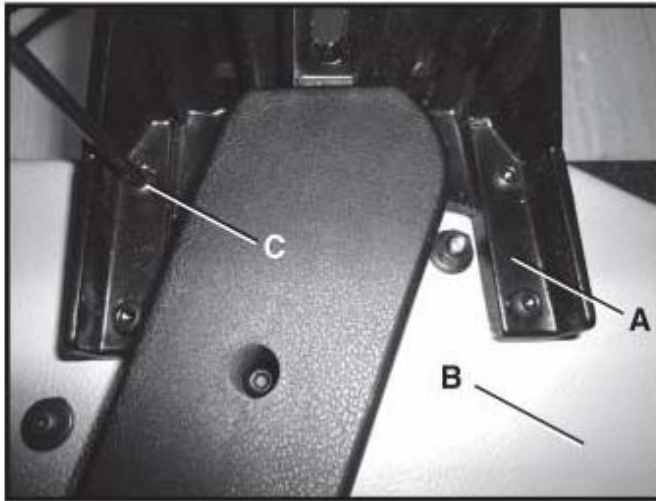

2. The square Nut (C) should fit in the groove of the fence. Assemble the fence sliding bracket (A) to the fence (B) SEE FIG. 2

Fig. 2

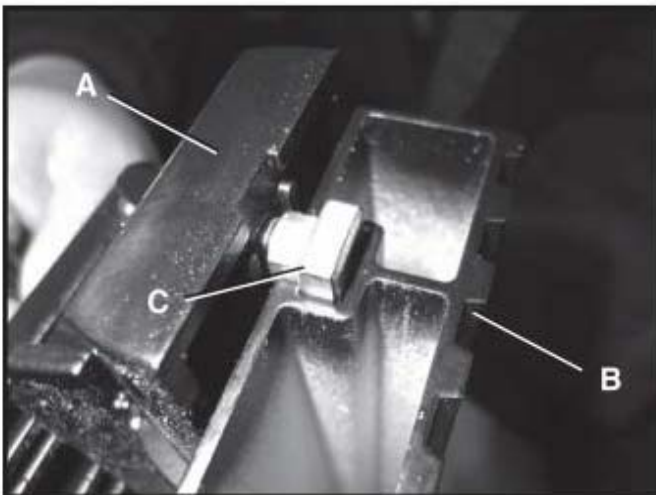

ASSEMBLY (cont.)

- Adjust the fence sliding bracket (A) to the middle of the fence (B), referring to the center of fence cut-out (C) use two M6x16mm soc button head screws (D) to lock the sliding bracket in position. SEE FIG. 3

Fig. 3

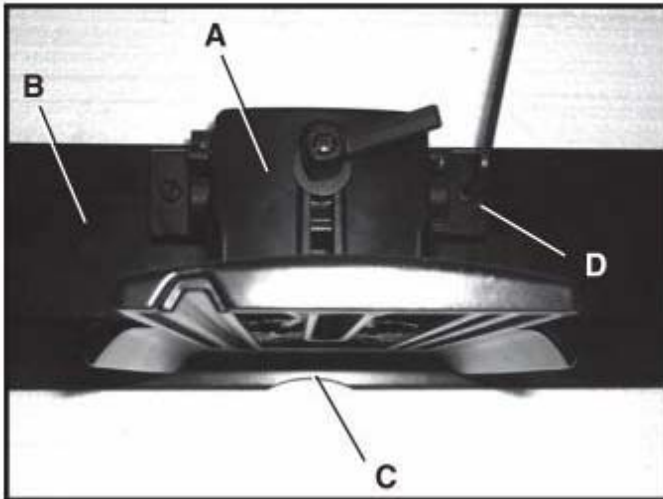

- Locate the sliding bracket & fence assembly on to the mounting bracket on the body of the jointer. Insert the tilt lock lever assembly (A) with the flat washer (B) in place. SEE FIG. 4

Fig. 4

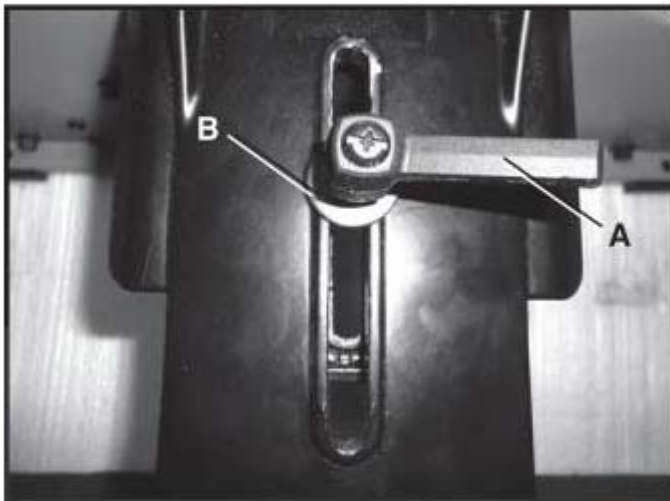

ASSEMBLY (cont.)

5. With the tilt lock lever assembly in between the mounting and sliding bracket, put on special nut (A), and turn the lever to lock both brackets into position. SEE FIG. 5

Fig. 5

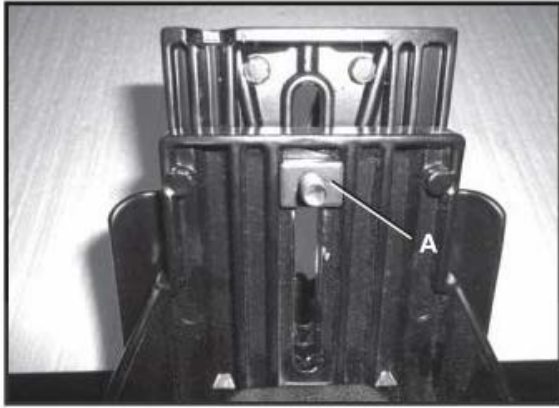

6. Use an angle gauge (A) to measure the 90° & 135° between the Fence and Jointer Table Top. Adjusting can be done by loosening or tightening the Hylock Hex Soc Head Screw (B). SEE FIG. 6 & 7

Fig. 6



Fig. 7

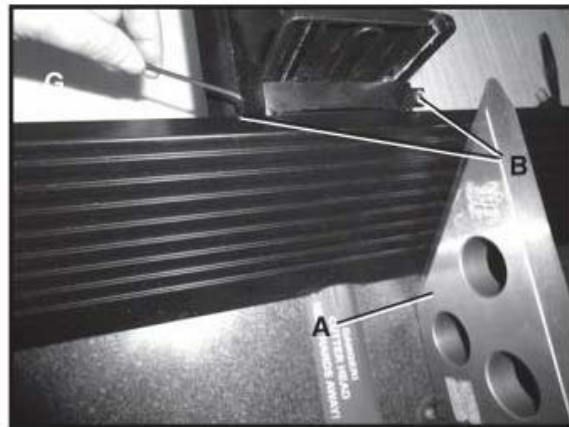

ASSEMBLY (cont.)

CUTTERHEAD GUARD ASSEMBLY

1. Attach cutterhead guard to the jointer by tightening the screw (A) SEE FIG. 8

Fig. 8



The cutterhead guard has a tension return spring. The tension on this spring is set at the factory. When the guard is installed properly it should return to the fence automatically after the work piece has passed over the cutterhead. Be sure the guard is functioning properly every time before using the jointer. If adjustment is necessary, remove the guard and while holding guard attachment base, rotate guard counter-clockwise to increase tension. Then mount guard base while holding guard and mounting base to prevent from losing tension.

DUST PORT ASSEMBLY

A dust port (A) is supplied with the jointer to help connect it to a standard 2-1/2 inch vacuum hose.

1. Tighten screws (B) by 4 mm hex wrench & screws (C) by phillips screwdriver when dust port (A) is in proper location. SEE FIG. 9

Fig. 9

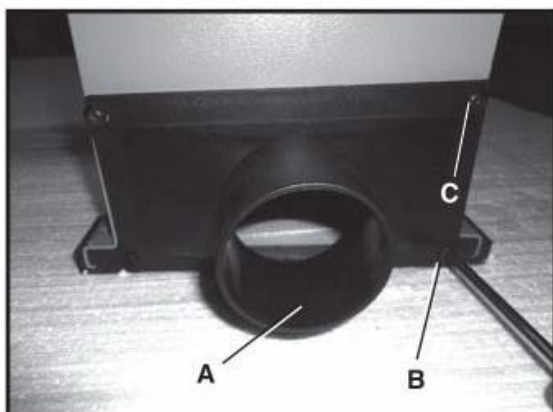

NOTE: Do not attach this dust port if you don't plan to use a dust collector.

ASSEMBLY (cont.)

LOCK KNOB ASSEMBLY

Attach knob (A) to the jointer by tightening the hex nut (B) by 10 mm, 13mm open end wrench (C).
SEE FIG. 10 & 11

Fig. 10

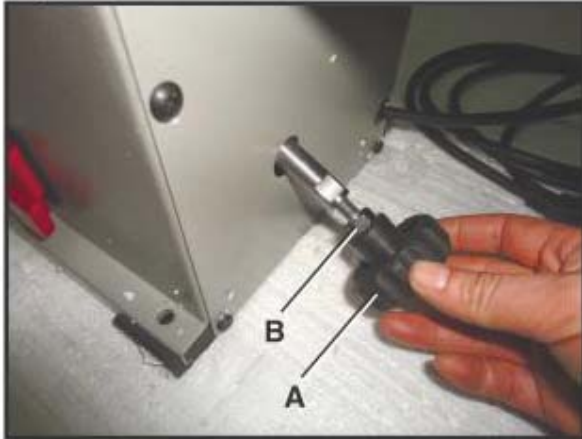
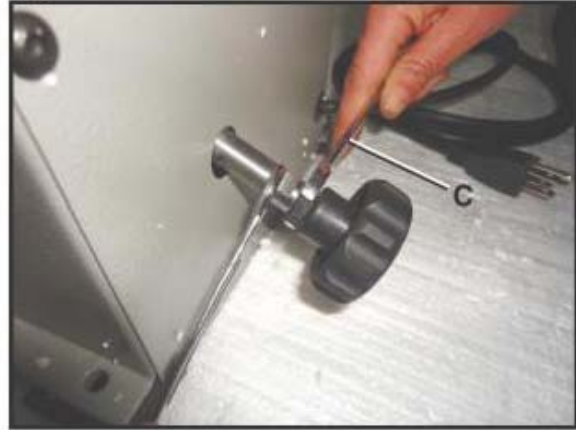

Fig. 11



SWITCH ASSEMBLY

The machine is fitted with a No Volt Release (NVR) safety switch. The NVR switch can only be activated if the machine is connected to mains power. During operation, any disruption to the mains power supply will see the this NVR switch release, preventing the machine restarting automatically. The user will need to physically re-start the unit after the cutterhead has come to a complete stop.

The jointer is started on by pressing the green ON button. In regular operation, the machine is switched off, by pressing the RED stop button.

ADJUSTMENTS

WARNING! MAKE CERTAIN THAT THE MACHINE IS DISCONNECTED FROM THE POWER SOURCE BEFORE ANY ADJUSTMENTS ARE MADE.

FENCE ADJUSTMENTS

1. To move the fence across the table by loosening lock lever (A), slide the fence to the desired position on the table and tighten lock lever (A). SEE FIG 16.

Fig. 16

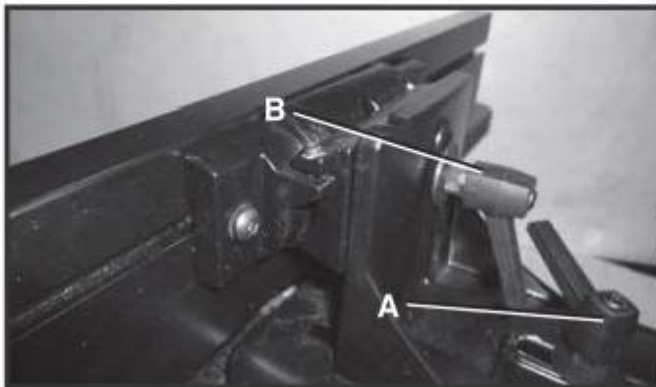

NOTE: Lock lever (A) and (B) can be repositioned by pulling up the lever and repositioning it on the nut located underneath the lever.

2. To tilt the fence, loosen tilt lock lever (B), and tilt the fence to the desired angle. Then tighten tilt lock lever (B) back SEE FIG 16.
3. The fence has adjustable positive stops at the most used fence positions of 90 and 135 degrees. To check and adjust the positive stops, proceed as follows:
4. Put a square (C) on the table with one end against the fence to adjust the fence until it is exactly 90 degrees to the table. SEE FIG 17.

Fig. 17



Fig. 18



ADJUSTMENTS (cont.)

5. Tighten set screw (D) by hex wrench until it contacts stop (E) SEE FIG 19.

Fig. 19

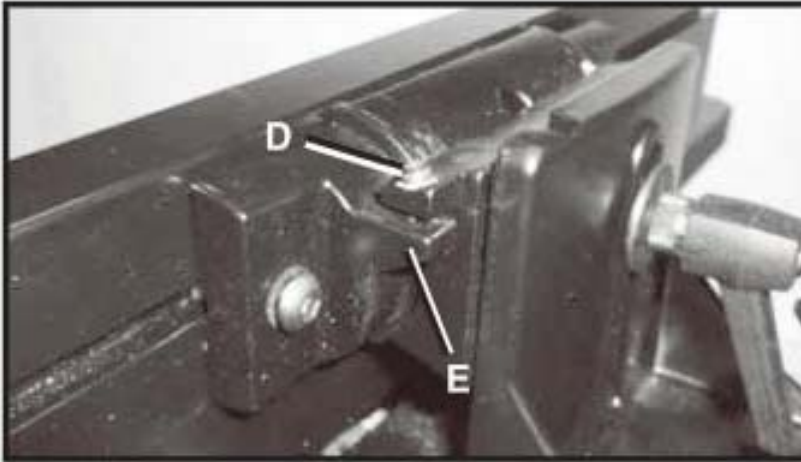

6. Put a square (C) on the table with one end against the fence to adjust the fence until it is exactly 135 degrees to the table. SEE FIG 18 on the previous page.
7. Tighten set screw (H) by hex wrench until it contacts stop (G) SEE FIG 20.

Fig. 20

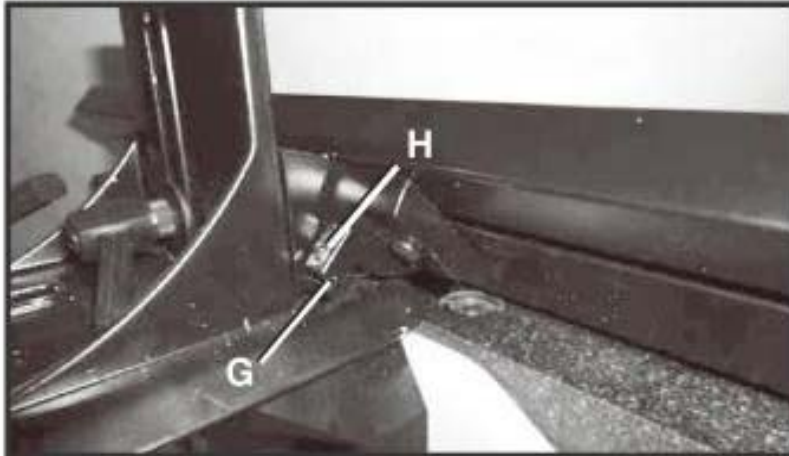

NOTE: These positive stops enable you to quickly position the table to the 90 and 135 degree settings.

ADJUSTMENTS (cont.)

WARNING! MAKE CERTAIN THAT THE MACHINE IS DISCONNECTED FROM THE POWER SOURCE BEFORE ANY ADJUSTMENTS ARE MADE.

INFEED / OUTFEED TABLE ADJUSTMENT

The infeed and outfeed tables are adjustable for coplanar or parallelism if ever necessary. These are set at the factory. If after planing or edge joining a work piece and adjustment is necessary, follow these instructions.

1. Lower the infeed table to its lowest setting.
2. Place a straight edge on the outfeed table across the cutterhead and check for parallelism.
3. The straight edge should lay flat on the outfeed table and the cutter tips should just touch the straight edge on both the front edge and rear of the table near the fence.
4. If the outfeed table is not level (parallel) with the cutterhead, remove and/or loosen the table screws and washers to access the leveling adjusters. SEE FIG A below.

FIG A.

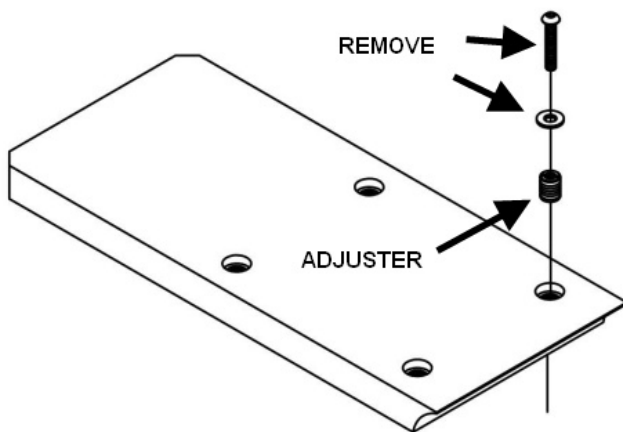

5. Using a slotted screwdriver, turn adjusters to level outfeed table with cutterhead.
6. Once parallel, replace the washers and screws.
7. Move the straight across the outfeed table, cutterhead, and over the infeed table
8. Raise the infeed table to just touch the straight edge.
9. If adjustment is necessary, use the procedure mentioned above for leveling (coplanar and parallel) the infeed table.

NOTE: These adjustments, if ever necessary, may take a few tries.

OPERATIONS

NOTE: This operations section was designed to give instructions on the basic operations of this jointer. However, it is in no way comprehensive of every jointer operation. It is strongly recommended that you read books, trade magazines, or get formal training to maximize the potential of your jointer while minimizing the risks.

WARNING! NEVER PASS HANDS DIRECTLY OVER THE CUTTERHEAD.

WARNING! ALWAYS USE CUTTERHEAD GUARD, PUSH BLOCKS, AND KEEP HANDS AWAY FROM CUTTERHEAD.

NOTE: THE KNIVES ON THE JOINTER WILL NOT WEAR EVENLY BY FEEDING THE WOOD THROUGH THE SAME SPOT ON THE TABLE EVERY TIME. FEED THE WOOD THROUGH THE JOINTER AT DIFFERENT SPOTS ON THE TABLE BY REPOSITIONING THE FENCE WHEN POSSIBLE, TO HELP ELIMINATE UNEVEN WEAR OF THE KNIVES.

STARTING AND STOPPING JOINTER

The machine is fitted with a No Volt Release (NVR) safety switch. The NVR switch can only be activated if the machine is connected to mains power. During operation, any disruption to the mains power supply will see the this NVR switch release, preventing the machine restarting automatically. The user will need to physically re-start the unit after the cutterhead has come to a complete stop.

The jointer is started on by pressing the green ON button. In regular operation, the machine is switched off, by pressing the RED stop button.

PLACEMENT OF HANDS DURING FEEDING

At the start of the cut, the left hand holds the work firmly against the infeed table and fence, while the right hand pushes the work toward the knives. After the cut is underway, the new surface rests firmly on the outfeed table. The left hand should then be moved to the work on the outfeed table, at the same time maintaining flat contact with the fence. The right hand presses the work forward, and before the right hand reaches the cutterhead, it should be moved to the work on the outfeed table.

OPERATIONS (cont.)

DIRECTION OF GRAIN

Avoid feeding work into the jointer against the grain. The result will be chipped and splintered edges. Feed with the grain to obtain a smooth surface. SEE FIG 14.

Fig. 14

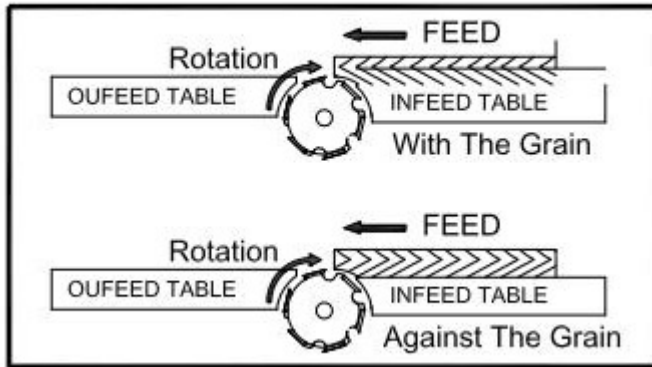

The jointer can be set to cut any depth from a very thin shaving to 1/8" deep. The pointer on the scale is to indicate the depth of cut. To adjust the depth of cut, loosen lock knob and turn adjusting knob clockwise to lower and counterclockwise to raise the infeed table until the infeed table is at the desired position. Retighten lock knob. SEE FIG 15.



FIG. 15

OPERATIONS (cont.)

PUSH BLOCKS

CAUTION! A set of push blocks (A) should be used whenever possible to minimize all danger to your hands. SEE FIG 21

Fig. 21



WARNING! ALWAYS USE PUSH BLOCKS WHEN PERFORMING SURFACING OPERATIONS AND NEVER PASS YOUR HANDS DIRECTLY OVER THE CUTTERHEAD.

JOINTING AN EDGE

This is the most common operation for the jointer. These cuts are made to square an edge of a work-piece. Set the guide fence square with the table. Depth of cut should be the minimum required to obtain a straight edge. Hold the best face of the piece firmly against the fence with push blocks throughout the feed. SEE FIG. 22.

Fig. 22



SURFACING / PLANING

Surfacing is similar to the edge jointing operation except for the position of the work piece. For surfacing, the major flat surface of the work piece is placed on the infeed table of the jointer with the narrow edge of the work piece against the fence. The work piece is moved from the infeed table, across the cutterhead to the outfeed table, establishing a flat surface on the work piece.

MAINTENANCE

WARNING! MAKE CERTAIN THAT THE MACHINE IS DISCONNECTED FROM THE POWER SOURCE BEFORE PERFORMING ANY MAINTENANCE PROCEDURES

Your jointer should provide you with a long time of service provided you take the time to perform the following maintenance operations.

CLEANING

Sawdust buildup and other debris can cause the tool to joint and plane incorrectly. Periodic cleaning and waxing is needed for accurate precision planing and jointing. Any moving parts should be cleaned regularly with penetrating oil and lubricated with a light coating of medium weight machine oil.

CAUTION! With the machine unplugged, blow off motor with low pressure air to remove dust or dirt. Air pressure above 50 P.S.I. should not be used as high-pressured air may damage insulation. The operator should always wear a respirator and eye protection when using compressed air. Do not allow chips and dust to accumulate under the machine. Keep area clean and in safe order.

Periodically clean, wax, and buff the tables. This will aid in the prevention of improper feeding of the work piece.

HARDWARE TIGHTNESS

Periodically check all clamps, nuts, bolts, and screws, for tightness and condition. Stop the machine and recheck the cutterhead screw and knives, or tips, for tightness after about 50 hours of operation. Recheck periodically.

MAINTENANCE (cont.)

WARNING! MAKE CERTAIN THAT THE MACHINE IS DISCONNECTED FROM THE POWER SOURCE BEFORE PERFORMING ANY MAINTENANCE PROCEDURES

BLADE (CUTTER INSERT) REPLACEMENT

WARNING:

To prevent serious personal injury

NEVER rotate the cutterhead by hand.

Cutter insert are razor sharp! Always wear heavy leather gloves when handling the cutterhead. Avoid touching the cutter insert by hand without protection.

The 6" cutterhead is equipped with 12 indexable cutter inserts. Each cutter insert can be rotated to reveal any one of its two cutting edges. Therefore, if one cutting edge becomes dull or damaged, simply rotate it 90° to reveal a fresh cutting edge.

In addition, each cutter insert has a reference mark on one corner. As the cutter insert is rotated, the reference mark location can be used as an indicator of which edges are used and which are new. See Figure 22.

FIG 22

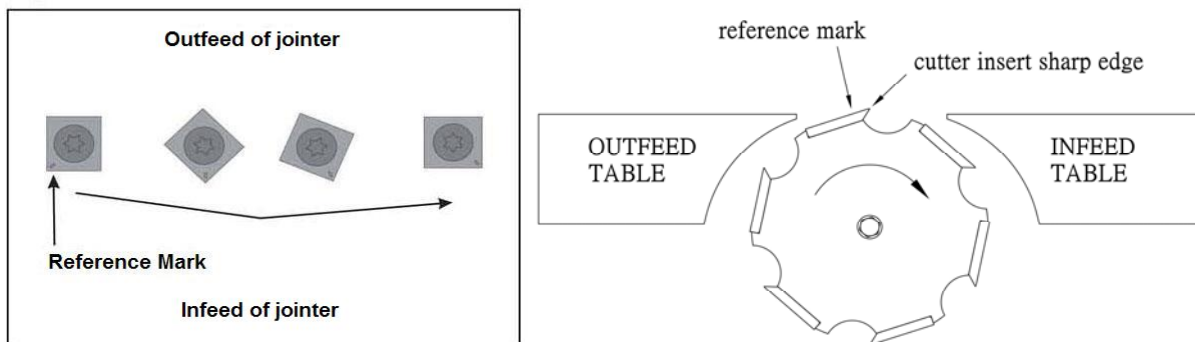

To rotate or change a cutter insert:

- DISCONNECT THE JOINTER FROM THE POWER SOURCE!
- Remove any sawdust from the head of the Torx screw.
- Remove the Torx screw and Cutter insert.
- Clean all dust and dirt off the cutter insert and the cutterhead pocket from which the cutter insert was removed, and replace the cutter insert so a fresh, sharp edge is facing outward. If available, try using pitch and gum remover to be sure all of the wood residue is off the cutterhead and cutter insert before attempting to rotate them. Using a shot of compressed air is also helpful, be sure to wear safety glasses.
- Lubricate the Torx screw threads with a light machine oil, wipe the excess oil off the threads, and torque the Torx screw to 48-50 inch/ pounds. When rotating a cutter insert, the cutter insert will seat itself before tightening.

MAINTENANCE (cont.)

Note: Proper cleaning is critical to achieving a smooth finish. Dirt or dust trapped between the cutter insert and cutterhead will slightly raise the cutter insert and make noticeable marks on your work piece the next time you use the machine.

REPLACING THE BELT

1. Use 4MM Allen Key to loosen the screw of belt guard. SEE FIG 23.



Fig 23

2. Push the belt outward, then screw the pulley on clockwise and disassemble the belt FIG 24



Fig 24

3. Ring the belt on the drive pulley. SEE FIGURE BELOW.



MAINTENANCE (cont.)

4. Press the belt on the cutterhead pulley. SEE FIG 26. Then rotate cutterhead pulley on clockwise and assemble the belt. SEE FIG 27.



Fig 26 & 27

5. Replace the belt guard. SEE FIG 28 and 29.



Fig 28 & 29

TROUBLESHOOTING GUIDE

Motor and Machine Operation

| PROBLEM | LIKELY CAUSE | SOLUTION |
|--|--|--|
| Motor will not start. | Not plugged in. Blown circuit. Lockout key removed. Improper Voltage. | Check the power source. Replace fuse, reset breaker, or call electrician. Replace lockout key. |
| Fuses or circuit breaker blows. | Short circuit in line cord or plug. Unit overloaded. | Call electrician to repair or replace cord or plug for damaged insulation and shorted wires. Reduce load. Operate on circuit separate from other appliances or motors or connect to circuit with adequate amp rating. |
| Motor fails to develop full power | Power supply circuit overloaded with lights, appliances, and other motors. Undersized wires or circuits too long. | Reduce load on circuit. Increase wire sizes or reduce length of the circuit. |
| Motor overheats. | Motor overloaded during operation. Air circulation through the motor restricted. | Reduce load on motor; take lighter cuts. Clean out motor to provide normal air circulation. |
| Motor stalls or shuts off during a cut. | Motor overloaded during operation. Short circuit in motor or loose connections. Circuit breaker tripped. | Reduce load on motor; take lighter cuts. Call electrician to repair or replace connections on motor for loose or shorted terminals or worn insulation. Install correct circuit breaker; reduce number of machines running on that circuit (circuit overload) |
| Blade slows when cutting or makes a squealing noise on start-up. | V-belt worn out. Dull cutter tips. | Replace V-belt. Replace or rotate tips. |

TROUBLESHOOTING GUIDE (cont.)

| PROBLEM | LIKELY CAUSE | SOLUTION |
|---|--|---|
| Vibration when operating jointer | Loose or damaged cutter tip. Damaged belt. Worn cutterhead bearing. | Tighten or replace knife. Replace belt Check/replace cutterhead bearing. |
| Infeed table hard to adjust | Table lock is engaged or partially engaged. | Completely loosen the table lock. |
| Work piece stops at the beginning of the cut. | Outfeed table is too high. | Align outfeed table with cutterhead knife at the dead center. |
| Chipping or tear out | Knots or conflicting grain direction in wood. Nicked or chipped blades. Feeding work piece too fast Taking too deep of a cut. | Inspect work piece for knots and grain; only use clean stock. Rotate or replace knife. Slow down the feed rate. Take a smaller depth for cut(always reduce cutting depth when surface planing or working with hard woods) |
| Fuzzy grain. | Wood may have high moisture content. Dull knives. | Check moisture content and allow to dry if moisture is too high. Replace knives. |
| Long lines or ridges that run along the length of the board. | Nicked, worn, or chipped knives. | Rotate or replace cutter tips. |
| Uneven cutter marks, wavy surface, or chatter marks across the face of the board. | Feeding work piece too fast Knives not adjusted at even heights in the cutterhead. | Slow down the feed rate Clean and adjust the knives so they are set evenly in the cutterhead. |
| Board edge is concave or convex after jointing | Board not held with even pressure on infeed and outfeed table during cut. Board has excessive bow or twist along its length. | Hold board with even pressure as it moves over the cutterhead. Take partial cuts to remove the high spots before a full pass. Surface plane one face so there is a good surface to position against the fence. It may take 3 to 5 passes to achieve a perfect edge depending on the condition of the board and the depth of cut. |

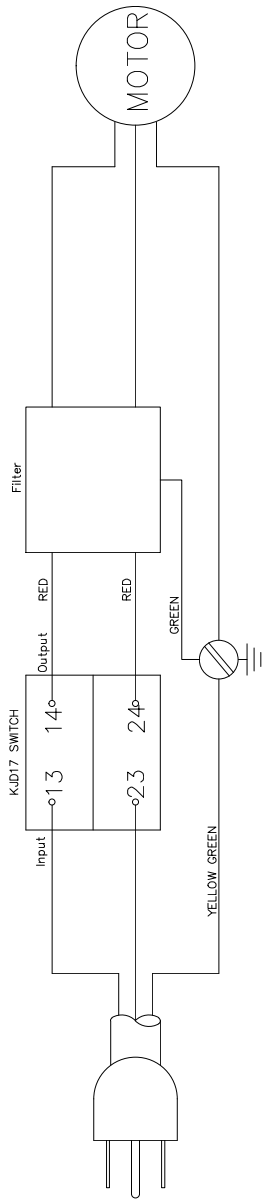

WIRING DIAGRAM

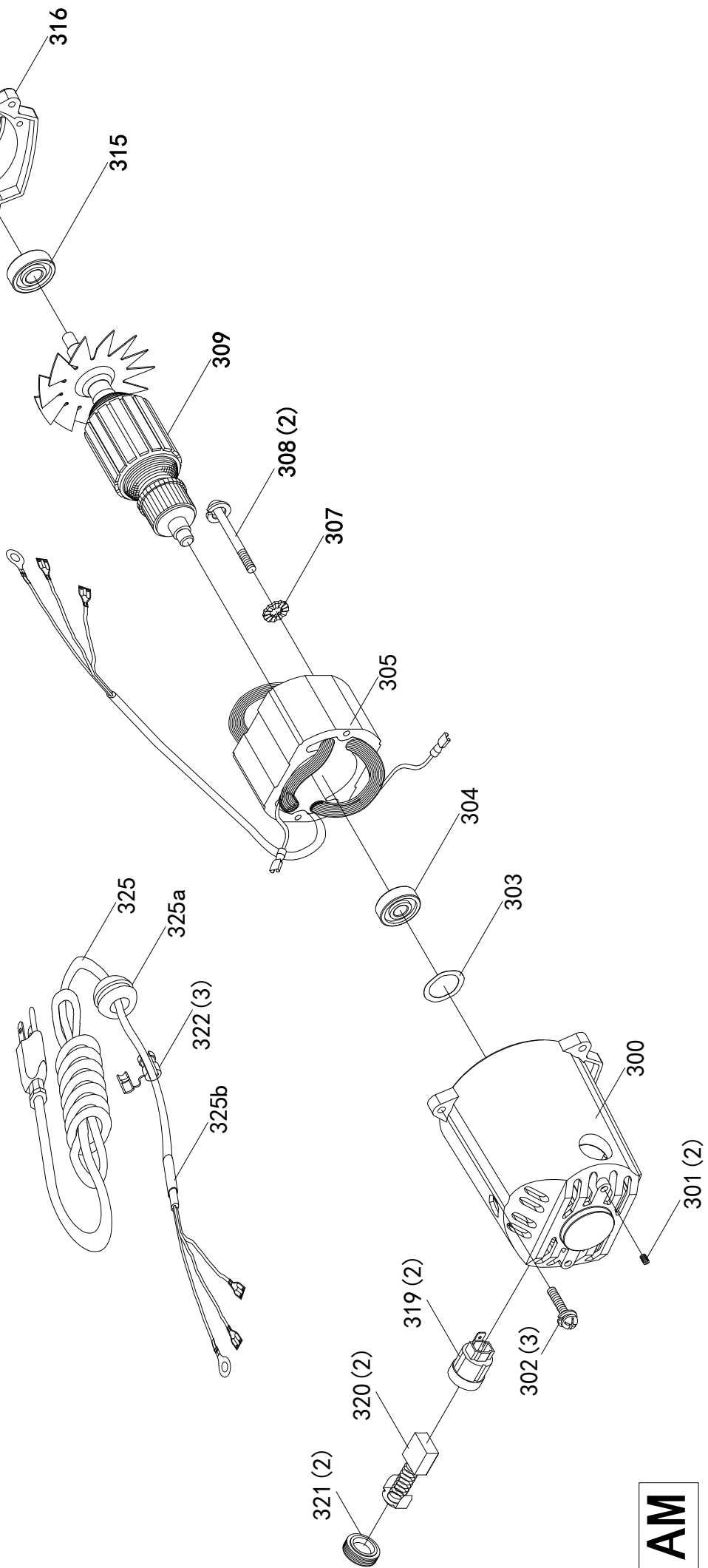

AM

**JN-BX150P_EXP //CARBATEC
March/27/2019 .By:DOOM.**

| Ser# | Drawing | Description | Spec | Qty |
|------|------------|-------------------------|--------------|-----|
| 3 | SPL 3006 | OUTFEED SUPPORT | | 1 |
| 4 | | HEX SOC SET SCREW | M6xP1.0x8L | 8 |
| 5 | PC160-005 | END COVER | | 1 |
| 6 | | BUTTON HD SCREW | M6xP1.0x12L | 19 |
| 7 | | SELF TAP SCREW | 1/4*5/8 | 4 |
| 8 | | WARNING LABEL | | 1 |
| 9 | SPL 3053 | FOAM SEAL | | 1 |
| 10 | PC160-010 | DUST CHUTE | | 1 |
| 11 | | LOGO | | 1 |
| 12 | SPL 3002 | FRONT FRAME | | 1 |
| 13 | | DUST PORT | | 1 |
| 14 | SPL 3017 | BEARING RETAINER | | 1 |
| 15 | 40160H-015 | SWITCH BOX | | 1 |
| 15a | 40160H-15a | SWITCH BOX COVER | | 1 |
| 16 | | BEARING | | 2 |
| 17 | | EXTERNAL RETAINING RING | | 1 |
| 20 | SPL 3032 | POINTER | | 1 |
| 21 | SPL 3035 | GEAR | | 1 |
| 22 | SPL 3038 | DEPTH SCALE | | 1 |
| 23 | PC160-23 | KNOB | M8*P1.25*18L | 2 |
| 24 | | FLAT WASHER | M8*23*2T | 3 |
| 25 | SPL 3037 | FOOT | | 4 |
| 26 | | EXT RETAINING RING | | 1 |
| 27 | | SCREW | M5*P0.8*8L | 2 |
| 27a | | WASHER | M5 | 2 |
| 27b | | NUT | M5 | 2 |
| 34 | PC160-34 | PLATE | | 1 |
| 35 | SPL 3047 | COVER | | 4 |
| 36 | SPL 3051 | BEARING RETAINER | | 1 |
| 38 | SPL 3021 | MOTOR PULLEY | | 1 |
| 39 | SPL 3020 | CUTTERHEAD PULLEY | | 1 |
| 40 | | BELT | | 1 |
| 41 | SPL 3027 | BELT GUARD | | 1 |
| 43 | SPL 3003 | TABLE | | 2 |
| 43a | | SCREW | M12*P1.25 | 8 |
| 48 | SPL 3036 | HWX FLANGE | M6 | 16 |
| 49 | SPL 3009 | TIE ROD | | 8 |
| 50 | SPL 3018 | CORD CLAMP | | 1 |
| 51 | SPL 3004 | INFEED SUPPORT | | 1 |
| 54 | | HEX SOC SET SCREW | M6*10L | 1 |
| 55 | SPL 3005 | BRACKET | | 1 |
| 56 | SPL 3056 | HEX SOC SET SCREW | M6*16L | 1 |
| 57 | | HEX NUT | M6 | 1 |

| Ser# | Drawing | Description | Spec | Qty |
|------|-----------|------------------------|-------------|-----|
| 58 | SPL 3007 | ADJUSTING ROD | | 1 |
| 59 | SPL 3008 | SHAFT | | 1 |
| 62 | PC160-62 | END COVER | | 1 |
| 64 | | HEX NUT | M8*P1.25*13 | 1 |
| 70 | | JOINTER PUSH BLOCK | | 2 |
| 71 | | HEX WRENCH | | 1 |
| 72 | | HEX WRENCH | | 1 |
| 74 | | SCREW | M6*P1.0*25L | 8 |
| 82 | | SCREW | ST4.2X19mm | 4 |
| 83 | | SCREW | ST4.2X25mm | 2 |
| 84 | | FILTER | | 1 |
| 100 | SPL 3048 | HOLE PLUG | | 1 |
| 101 | SPL 3015 | GUARD ASSY | | 1 |
| 102 | | WARNING LABEL | | 1 |
| 103 | SPL 3019 | BUMPER SHOE | | 1 |
| 104 | SPL 3044 | SPRING | | 1 |
| 105 | SPL 3016 | BRACKET | | 1 |
| 106 | | EXT RETAINING RING | | 1 |
| 116 | | LABEL | | 1 |
| 125 | SPL 3031 | FENCE | | 1 |
| 126 | | CAUTION LABEL | | 1 |
| 127 | | LABEL | | 1 |
| 128 | PC160-128 | BEVEL BRACKET | | 1 |
| 129 | SPL 3049 | SQUARE NUT | | 2 |
| 130 | SPL 3052 | SPECIAL NUT | | 2 |
| 131 | | HYLOK HEX SOC HD SCREW | M5*P0.8*8L | 2 |
| 132 | PC160-132 | INTERMEDIATE BRACKET | | 1 |
| 133S | | TILT LOCK LEVER ASSY | | 1 |
| 135S | | TILT LOCK LEVER ASSY | | 1 |
| 136 | SPL 3040 | FENCE SLIDE BRACKET | | 1 |
| 137 | SPL 3039 | FENCE BRACKET | | 1 |
| 139 | | SCREW | M6X16L | 6 |
| 140 | | LABEL | | 1 |
| 160S | | CUTTERHEAD | | 1 |
| 162 | | BLADE | | 12 |
| 163 | | SCREW | | 12 |
| 166 | | WRENCH | | 1 |
| 200 | | CARTON | JN-BX150P | 1 |
| 202 | | MANUAL | | 1 |
| 300 | 1345913 | MOTOR COVER | | 1 |
| 300S | | MOTOR | | 1 |
| 301 | | SCREW | M5*P0.8*8L | 2 |
| 302 | | SCREW | M5*P0.8*20L | 3 |

| Ser# | Drawing | Description | Spec | Qty |
|------|---------|---------------|------------------|-----|
| 303 | | WASHER | ø29.4*ø22.9*0.4T | 1 |
| 304 | | BEARING | | 1 |
| 305 | 1345912 | STATOR | | 1 |
| 307 | | WASHER | M5 | 1 |
| 308 | | SCREW | M4.8*P2.0*55L | 2 |
| 309 | 1345911 | ROTAR | | 1 |
| 315 | | BEARING | | 1 |
| 316 | 1345909 | END COVER | | 1 |
| 317 | | WASHER | M6*ø12.5*2.0T | 3 |
| 319 | 1345704 | BRUSH HOLDER | | 2 |
| 320 | 1345914 | BRUSH | | 2 |
| 321 | 1345925 | BRUSH CAP | | 2 |
| 322 | 898475 | STRAIN RELIEF | | 3 |
| 323 | 1343759 | SWITCH | | 1 |
| 323a | | SWITCH COVER | | 2 |
| 325 | 1345929 | POWER CORD | | 1 |



2

YEAR

WARRANTY

WARRANTY

1. WARRANTY

- (a) We warrant that this **carbatec** product will be free from defects caused by faulty workmanship or faulty materials for a period of **2 years from date of sale**.
- (b) This warranty is in addition to other rights and remedies you may have under a law in relation to the goods.
- (c) This warranty does not apply in any of the following cases:
 - (i) defects arising from:
 - (1) fair wear and tear;
 - (2) corrosive atmosphere;
 - (3) damage or injury caused by deliberate act, lack of care or failure to comply with the recommended care and maintenance for the goods;
 - (4) improper use of the goods;
 - (5) alterations or repairs (not made by us) to the goods;
 - (ii) defects arising from an event outside of our control such as fire, flood, earthquake or other natural calamity, motor vehicle or other accident, strike, civil unrest, terrorism or war;
 - (iii) to accessory items such as after-market jigs, accessories or other items which are not sold or serviced by us and which are not sold with or were not included with the main unit purchased; or
 - (iv) to wearable parts such as drive belts/shafts, bearings, bandsaw tyres, motor brushes, blades or abrasive belts/discs or other cutting or machining implements.
 - (v) damage caused to any electrical component, where connected to a power supply outside the country for which it was designed (namely Australia or New Zealand).
- (d) If this warranty applies and you have complied with the procedure below for making a claim, we will, at our election, either repair the goods (or those parts of the goods recognised as defective) or will provide a replacement within a reasonable time at our expense.
- (e) If this warranty applies, the procedure for making a claim is:
 - (i) you must contact us by email;
 - (ii) you must include in the email the following information:
 - (1) a copy of the order or receipt for the goods;
 - (2) the serial or batch number printed on the machinery manufacturing plate; and
 - (3) a detailed description of the fault and how and when it arose; and
 - (iii) if the fault is a type covered by this warranty, we will then make arrangements with you for the return of the goods to us (for repair or replacement) at our cost using our transport providers or we may decide to attend at your premises to repair or replace the goods.
- (f) Our liability (and that of our resellers) under this warranty is wholly limited to repair or replacement of the goods (or those parts of the goods recognised as defective) in accordance with the procedure above and you have no right to other compensation, costs or damages under this warranty. But this does not mean that you may not have other rights under a law in relation to the goods.
- (g) If following our inspection of goods returned by you under this warranty it is found that this warranty does not apply and you are not otherwise entitled to repair or replacement by us, you must, if requested by us, reimburse our costs including parts, labour and freight.
- (h) This warranty is not transferable and only the person who purchased the goods may make a claim.
- (i) Where the goods have been exported outside Australia or New Zealand, the Company may not require the Purchaser to return any allegedly faulty or defective Product for evaluation. However, the Company has the right to request the return for evaluation at purchasers cost.

2. STATUTORY NOTICE

Our goods come with guarantees that cannot be excluded under the Australian Consumer Law. You are entitled to a replacement or refund for a major failure and for compensation for any other reasonably foreseeable loss or damage. You are also entitled to have the goods repaired or replaced if the goods fail to be of acceptable quality and the failure does not amount to a major failure.

3. CONTACT DETAILS

Carbatec Pty Ltd ABN 84 010 706 242

info@carbatec.com.au | Phone 1800 658 111 | www.carbatec.com.au

128 Ingleston Road, Wakerley, QLD Australia 4154

Carbatec Pty Ltd
ABN 84 010 706 242

info@carbatec.com.au

Phone: 1800 658 111
128 Ingleston Road, Wakerley
Queensland Australia 4154

www.carbatec.com.au

carbatec