

novaTM

Smart Tools, Powerful Solutions

Viking DVR 16"

Benchtop Drill PressTM

OPERATION MANUAL

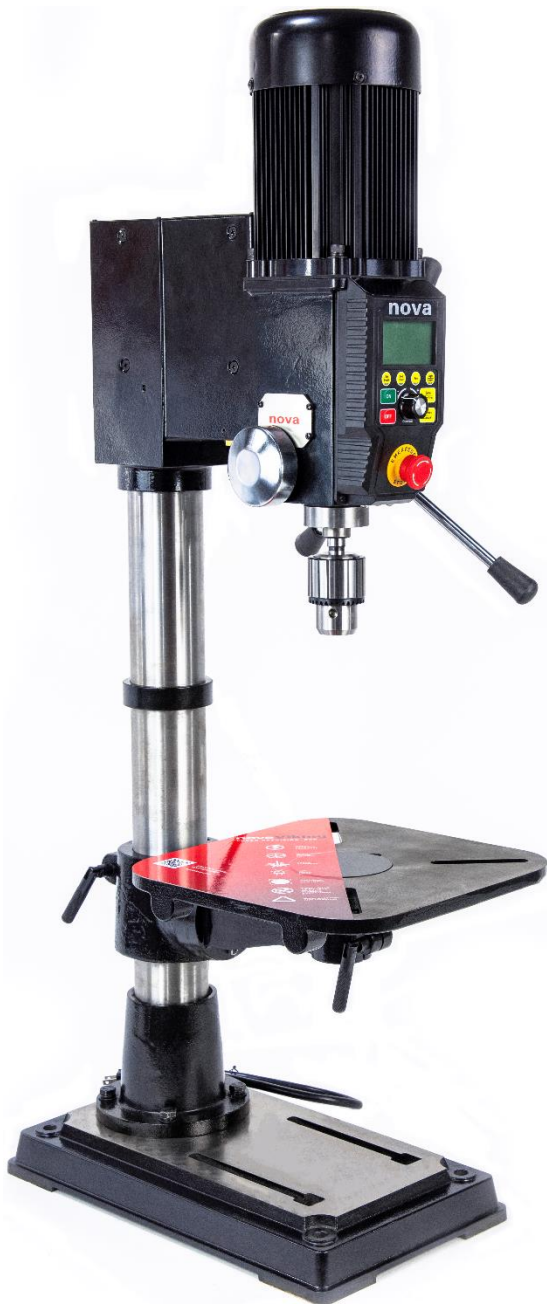

Publication: 123-0719-018

Date: 11 July 2019

Models:

- 83700 - USA
- 83701 - NZ/Australia
- 83702 - Canada
- 83703 - Europe
- 83704 - UK

Contact

Teknatool International Ltd

Phone: (+64) 9 477 5600

Teknatool USA

Phone: 727-954-3433

Customer Solutions

For all worldwide Inquiries, Repairs or Services (issues must be in writing)

Email: Service@Teknatool.com

Or you can contact the retailer where you purchased your NOVA Viking DVR Drill Press, for the contact details please see our website www.teknatool.com

Table of Contents

Contact.....	2
Table of Contents.....	3
General Safety Rules.....	5
Additional Safety Rules for Drill Presses.....	6
NOVA DVR Viking Features.....	1
Drill Press Features.....	1
Drill Press Specifications.....	2
Package Contents.....	3
Assembling the Drill Press.....	4
Drill Press Body.....	4
Drill Chuck and Arbor.....	4
Drill Press Handle.....	5
Chuck and Arbor Assembly Attachment.....	5
Attaching the Drill Press Table.....	6
Tilting the table.....	6
Attaching the Chuck Guard.....	7
Connecting to Power.....	8
Ground Fault Interrupters (GFI).....	9
Setting up your drill press.....	9
Setting up your workshop environment.....	9
Drill Press Interface.....	10
Keypad Buttons.....	10
Display Icons.....	10
Operating the Drill Press.....	12
Turning the Drill Press ON.....	12
Basic Drill Press Functions.....	12
Running the drill press.....	12
Stopping the drill press.....	13
Emergency Stop.....	13
Adjusting the speed.....	13
Changing the display mode.....	14
Changing the measurement units.....	14
Switching between forward and reverse.....	15
Zeroing the depth.....	16

Using the light and lasers	17
Intermediate Functions.....	18
Using the electronic depth stop function	18
Quick Set Depth Function	19
Electronic Depth Stop Function	19
Using the Self-Start Function	20
Power Spindle Hold Function.....	21
Advanced Functions.....	22
Performing a Factory Reset.....	22
Turning the sound on or off.....	22
Changing the power bar settings	23
Calibrating the Height Sensor Drill Press	24
Unlocking the drill press speed range to 6000rpm.....	24
Changing the drill press depth stop behaviour	25
Maintaining your Drill Press.....	26
Maintenance after each use	26
Monthly maintenance.....	26
6month Maintenance	26
Speed Chart for Metal Drilling	26
Full Speed Chart for General Materials.....	27
Firmware Update	28
Checking the firmware version	28
USB Mode	29
Troubleshooting.....	30
Mechanical Issue.....	30
Electrical Issues	32
Error Codes	32
Teknatool Warranty.....	33
Viking Drill Press Headstock Breakdown	34
Viking Drill Press Stand and Base	35
NOVA Viking Drill Press Parts List	36
Chuck Guard.....	39
Appendix	40
NOVA Viking Wiring Diagram.....	40
Using the included accessories	41
Chuck Drift.....	41

General Safety Rules



WARNING! Failure to follow these rules may result in serious personal injury or death.

IMPORTANT: Before switching the drill press on, **ALWAYS** check the machine for the correct setting and speed, as well as ensuring the Chuck Key is removed.

- 1. FOR YOUR OWN SAFETY, READ THE MANUAL BEFORE OPERATING THE TOOL.** Learn the machine's application and limitations, plus the specific hazards particular to it.
- 2. ALWAYS USE SAFETY GLASSES** (must be ANSI approved) Everyday eyeglasses usually are only impact resistant and safety glasses only protect eyes. A full-face shield will protect the eyes and face. Also use face or dust mask if cutting operation is dusty.
- 3. WEAR PROPER APPAREL.** Do not wear loose clothing, gloves, neckties, rings, bracelets or other jewelry which may get caught in moving parts. Nonslip footwear is recommended. Wear protective hair covering to contain long hair.
- 4. USE EAR PROTECTORS.** Use ear muffs for extended period of operation. Use muffs rated to 103 DBA LEQ (8 hour).
- 5. DON'T USE IN DANGEROUS ENVIRONMENT.** Don't use power tools in damp or wet locations, or expose them to rain. Keep work area well lighted. The NOVA Viking DVR Drill press is intended for indoor use only. Failure to do so may void the warranty.
- 6. KEEP WORK AREA CLEAN.** Cluttered areas and benches invite accidents. Build-up of sawdust is a fire hazard.
- 7. KEEP CHILDREN AND VISITORS AWAY.** The Nova Viking DVR is **not recommended** for children and infirm persons. Such personnel and onlookers should be kept a safe distance from work area.
- 8. MAKE WORKSHOP CHILDPROOF** with locks, master switches, or by removing starter keys.
- 9. GROUND ALL TOOLS.** If the tool is equipped with a three-prong plug, it should be plugged into a three-hole electrical receptacle. If an adapter is used to accommodate a two-prong receptacle, the adapter plug must be attached to a known ground. Never remove the third prong.
- 10. MAKE SURE TOOL IS DISCONNECTED FROM POWER SUPPLY** while the motor is being mounted, connected, or reconnected.
- 11. DISCONNECT TOOLS FROM WALL SOCKET** before servicing and when changing accessories such as bits, cutters and fuses etc.
- 12. AVOID ACCIDENTAL STARTING.** Make sure switch is in the "Off" position before plugging in power cord.
- 13. NEVER LEAVE MACHINE RUNNING UNATTENDED.** Do not leave machine unless it is turned off and has come to a complete stop
- 14. KEEP GUARDS IN PLACE** and in working order.
- 15. USE CORRECT TOOLS.** Do not use a tool or attachment to do a job for which it was not designed.
- 16. USE RECOMMENDED ACCESSORIES.** The use of improper accessories may cause hazards.
- 17. DON'T FORCE THE TOOL.** It will do the job better and be safer at the rate for which it was designed.
- 18. MAINTAIN TOOLS IN TOP CONDITION.** Keep tools sharp and clean for best and safest performance. Follow instructions for lubricating and changing accessories.
- 19. NEVER STAND ON TOOL.** Serious injury could occur if the tool is tipped or if the cutting tool is accidentally contacted.
- 20. REMOVE ADJUSTING KEYS AND WRENCHES.** Form a habit of checking to see that keys and adjusting wrenches are removed from tool before turning it on.
- 21. DON'T OVERREACH.** Keep proper footing and balance at all times.
- 22. DIRECTION OF FEED.** Feed work into a blade or cutter against the direction of rotation of the blade or cutter only.
- 23. PAY ATTENTION TO WORK.** Concentrate on your work. If you become tired or frustrated, leave it for a while and rest.
- 24. SECURE WORK.** Use clamps or a vice to hold work when practical. Severe injury or death can occur if an object comes free as it can become a dangerous projectile.
- 25. CHECK DAMAGED PARTS.** Before further use of the tool, any part that is damaged should be carefully checked to ensure that it will operate properly and perform its intended function. Check for alignment of moving parts, binding of moving parts, mounting, and any other conditions that may affect its operation. Any damaged part should be properly repaired or replaced.
- 26. DRUGS, ALCOHOL, MEDICATION.** Do not operate machine while under the influence of drugs, alcohol, or any medication.
- 27. DUST WARNING.** The dust generated by certain woods and wood products can be harmful to your health. Always operate machinery in well-ventilated areas and provide means for proper dust removal. Use wood dust collection systems whenever possible.
- 28. DO NOT MODIFY OR USE DRILL PRESS FOR USES OTHER THAN FOR WHICH IT WAS DESIGNED.**

Additional Safety Rules for Drill Presses













WARNING! Failure to follow these rules may result in serious personal injury.

1. **SEEK INSTRUCTION.** If you are not thoroughly familiar with the operation of drill press, obtain advice from your supervisor, instructor, or other qualified person. Instruction from a qualified person is strongly recommended.
2. **DO NOT OPERATE DRILL PRESS** until it is completely assembled and installed. Follow instructions and recommendations.
3. **FOLLOW ELECTRICAL CODES.** Make sure wiring codes and recommended electrical connections are followed and that the machine is properly grounded.
4. **WHEN REPLACING THE FUSE** (on relevant models), completely isolate power when removing the fuse. It is imperative the plug is removed from the power supply before the fuse is removed. Replace fuse cap before reconnecting to power.
5. **DO NOT OPEN THE SWITCH AND REAR COVERS.** Components can carry dangerous voltages even when isolated from mains power.
6. **KEEP WORK AREA CLEAN.** Do not turn the drill press on before clearing the drill press of all objects (tools, scraps of wood, etc.). Keep the nearby area and floor clear of debris.
7. **CHECK SET-UP** with spindle off. Examine the set-up carefully and rotate the work piece by hand to check clearance and check speed is correctly selected before turning on spindle.
8. **DO NOT MAKE ADJUSTMENTS** when the drill press spindle is turning. Make all adjustments with power OFF.
9. **TIGHTEN ALL CLAMP HANDLES** on the drill press before operating drill press.
10. **ALWAYS CHECK CORRECT SPEED IS SELECTED BEFORE SWITCHING ON DRILL PRESS.**
11. **OPERATE AT RECOMMENDED SPEED.** Always operate the drill press at the recommended speeds. Consult the built-in speed chart on the drill press for suggested speeds.
12. **DO NOT OPERATE DRILL PRESS IF DAMAGED OR FAULTY.** If any part of your drill press is missing, damaged or broken, in any way, or any electrical component fails, shut off the drill press and disconnect the drill press from the power supply. Replace missing, damaged, or failed parts before resuming operation.
13. **ADDITIONAL SAFETY INFORMATION** regarding the safe and proper operation of this product is available from the National Safety Council, 444 N. Michigan Avenue, Chicago, IL 60611 in the Accident Prevention Manual of Industrial Operations and also in the Safety Data Sheets provided by the NSC. Also refer to the American National Standards Institute ANSI O1.1 Safety Requirements for Woodworking Machines and the U.S Department of Labor OSHA 1910.213 Regulation.

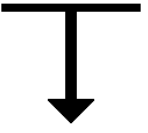
NOVA DVR Viking Features

Drill Press Features

	<p>DIRECT DRIVE POWER AND CONSISTENT TORQUE</p>	<p>1HP DVR Smart Digital Motor delivers correct speed, and power to maintain optimal torque direct to the drill head, across the entire speed range. No belts or pulleys to cause vibration or power loss.</p>	<p>A belt and pulley system absorb typically 20% of the motor power before it even gets to the tool. The DVR motor delivers constant torque no matter what the materials</p>
	<p>SMART DIGITAL MOTOR</p>	<p>Smart sensors interacting in a number of ways safety, intelligence workshop assist, and performance</p>	
	<p>BUILT IN LASER AND LIGHT</p>	<p>Quickly locate centre position with the cross haired laser– laser stays aligned even when table is moved or tilted, and the DVR low/no vibration performance means laser won't move in operation. Two powerful LED lights to keep your project well lit.</p>	
	<p>CAST IRON WOODWORKING TABLE</p>	<p>Maximum flexibility and options for the user. Solid Cast Iron for maximum stability. Woodworking design to provide maximum clamping and accessory options</p>	<p>12 2/3" x 12 2/3" (320mm x 320mm). Tilting and Rotating</p>
	<p>ELECTRONIC VARIABLE SPEED</p>	<p>Versatile for a variety of projects – from large deep hole drilling, mortising, through to high speed sanding.</p>	
	<p>DISPLAY</p>	<p>Large, easy to read display with imperial (fractions or decimal) or metric provides choice with that the customer prefers to use. Easy to switch between modes.</p>	
	<p>FORWARD AND REVERSE</p>	<p>For LH drill bits, gives the owner more flexibility for projects.</p>	
	<p>ELECTRONIC DEPTH STOP</p>	<p>Quickly and accurately automatically stops to the precise depth you program for your project.</p>	

	SELF-START	Enables a one-handed drilling operation by automatically turning on and off.	
	SPLIT MOTOR (EXPOSED)	Easy access to motor. Much easier to get serviced for both customers and dealers.	
	BRAKING	E-stop	

Drill Press Specifications

Drill Press Physical Specifications	
Swing	16" (406.4mm)
Stroke	4.5" (114.3mm)
Spindle to Table	12 2/3" (321.73mm)
Spindle to Base	22 2/3" (575.73mm)
Drill Chuck	5/8" (2- 15.87mm)
Spindle Taper	2MT
Quill Diameter	60mm
Table Dimension	320 x 320mm
Base Dimension	468.7 x 270 x 55mm
Motor Specifications	
Motor Type	DVR Direct Drive Smart Motor
Motor power output	1HP (0.75KW)
Maximum Speed	3000 RPM (6000 RPM when unlocked)
Input voltage	110V ~ 220V
Input Frequency	50/60 Hz
Input Current	15A (max)

Package Contents

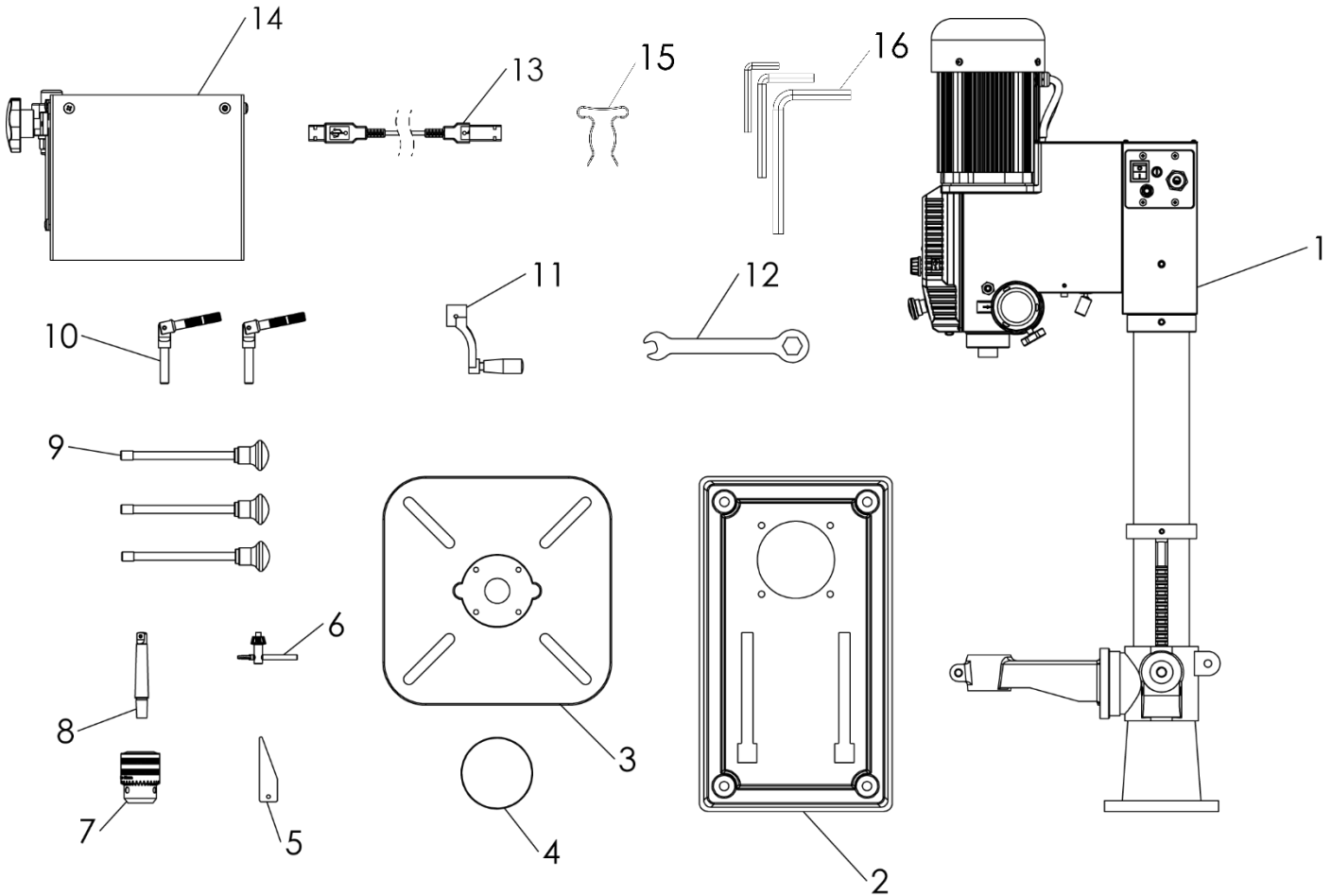

Item Number	Description	SKU
1	Viking Drill Press Body	8379001~8379008
2	Drill Press Base	8379025
3	Drill Press Table	8379022
4	Table Insert	8379024
5	Chuck Drift	8379067
6	Chuck Key	8379069
7	Drill Press Chuck	8379068
8	Chuck Arbor	8379019
9	Drill Press Handle (x3)	8379044
10	Table Arm Locking Handle (x2)	8379064
11	Table arm handle	8379028
12	Open end wrench	8379066
13	USB A-A cable	8379059
14	Chuck Guard Assembly	8379009
15	Chuck Key Holder	8379102
16	Allen Key Set	AK3, AK4, AK5

Note: The Chuck Guard Assembly is only included as standard for the EU model

Assembling the Drill Press

Drill Press Body

The NOVA Viking drill press come with its headstock preassembled with its main column.

Caution

The headstock assembly can be heavy and it is a subject to tip over. **It is recommended to have at least 2 people when assembling the drill press.**

Attaching the drill press base

1 Align the thread holes on the drill press base and column base



2 Bolt the bases together with the M10 bolt

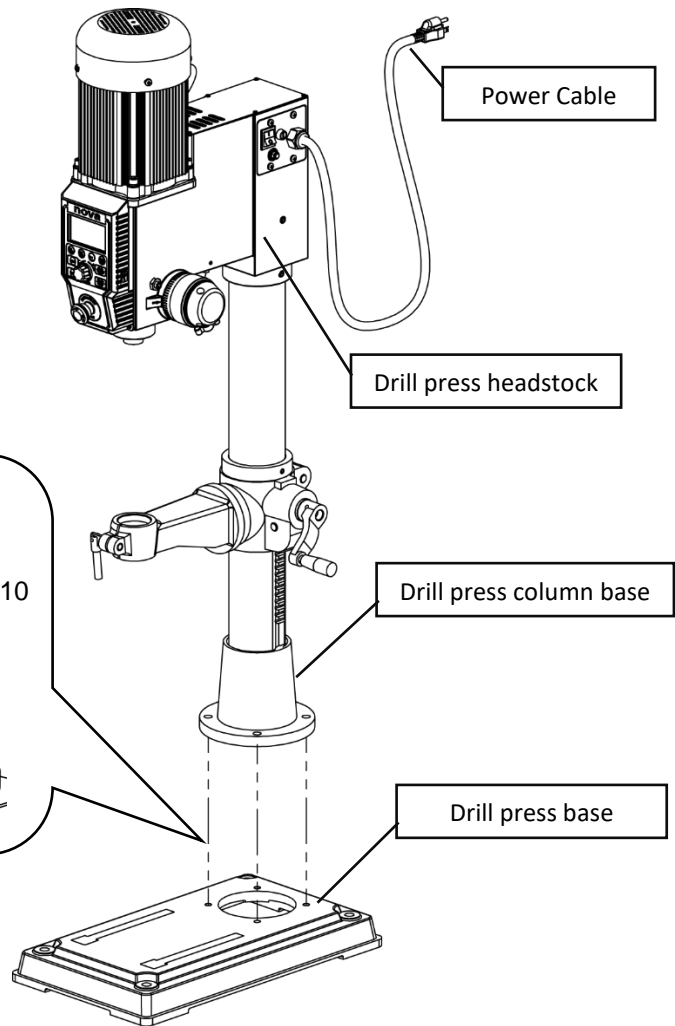
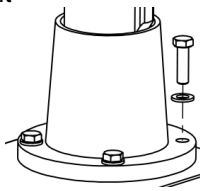

Drill Chuck and Arbor

Before assembling

Wipe down all surfaces which makes contact with other parts free of any dusts or lubricants.

- Both long and short side of Arbor
- Tapered hole of the chuck

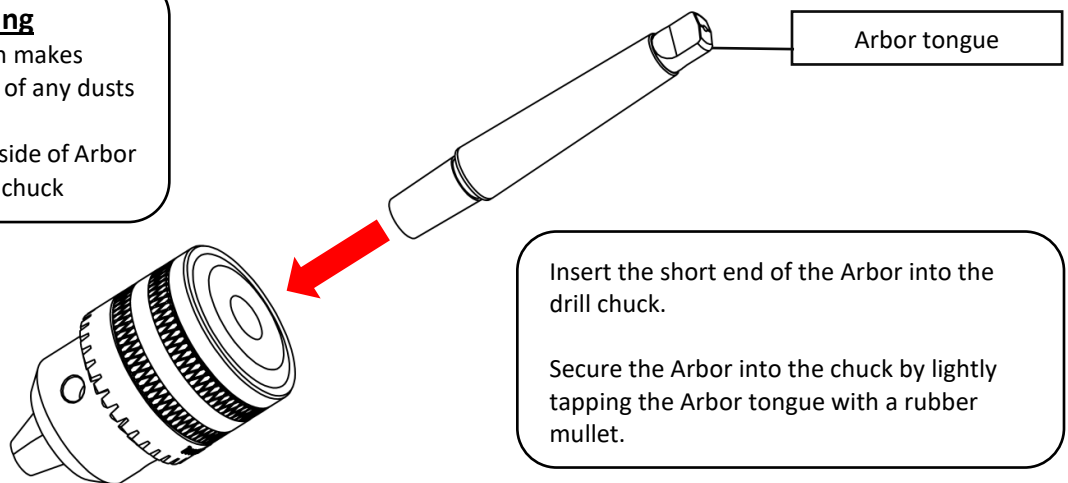

Drill Press Handle

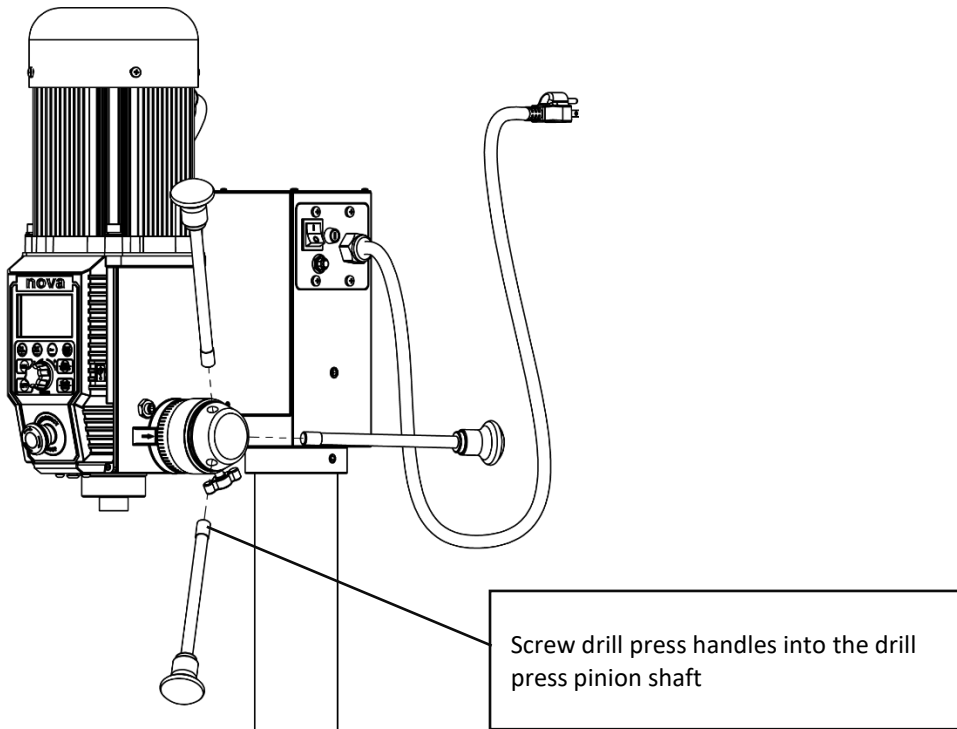

Chuck and Arbor Assembly Attachment

Insert the arbor into the drill press quill.

Note:
Make sure the arbor tongue is facing the correct direction.

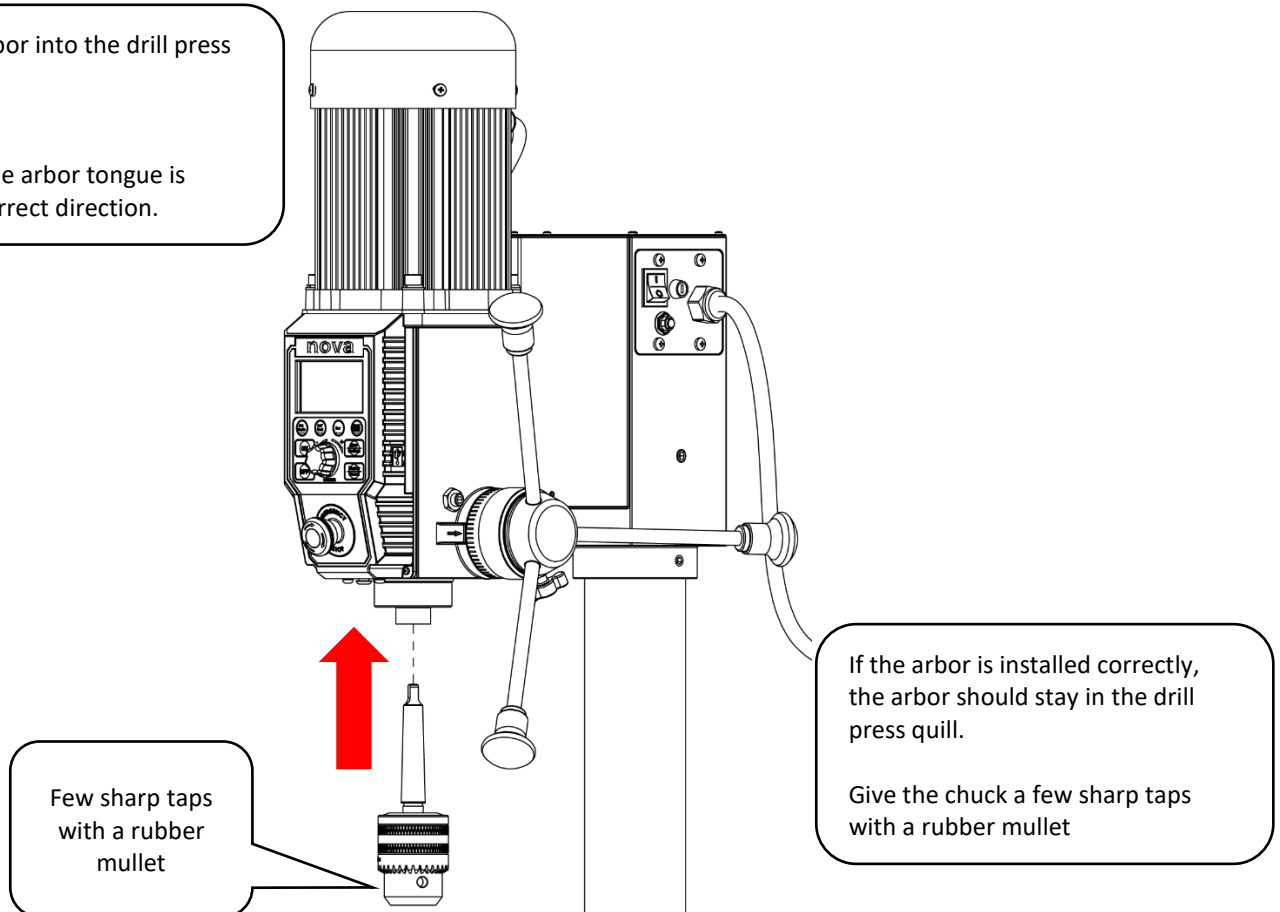

Attaching the Drill Press Table

Take the drill press table out from the packaging and inspect all surfaces for and defects (i.e. Stains, rusts, fractures, scratches) on the machined cylindrical part of the table.

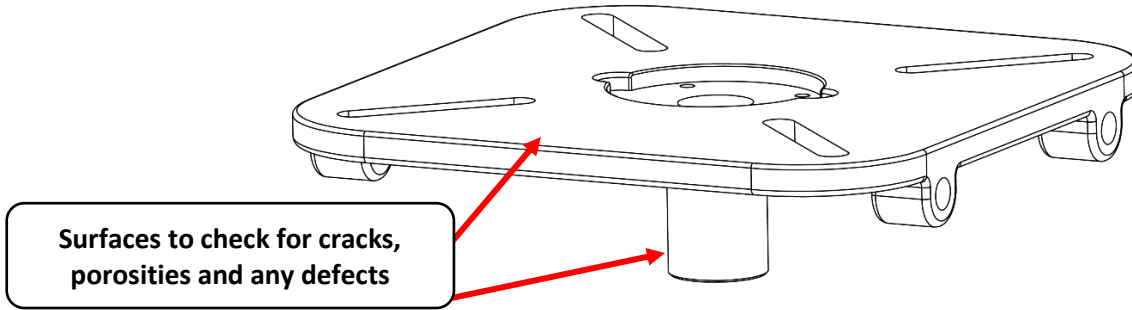

Insert the drill press table into the table arm.

Loosen the table arm lock if necessary.

This handle is used to lock the inserted table into place.
Loosen this handle if the table cannot be inserted easily

This diagram shows the drill press table arm with the table inserted. A red circle highlights a handle on the side of the arm, which is used to lock the table in place. A callout box points to this handle with the text: "This handle is used to lock the inserted table into place. Loosen this handle if the table cannot be inserted easily".

Tilting the table

Loosen the main table bolt with a 24mm wrench and loosen the smaller grub screw with <Allen Key>.

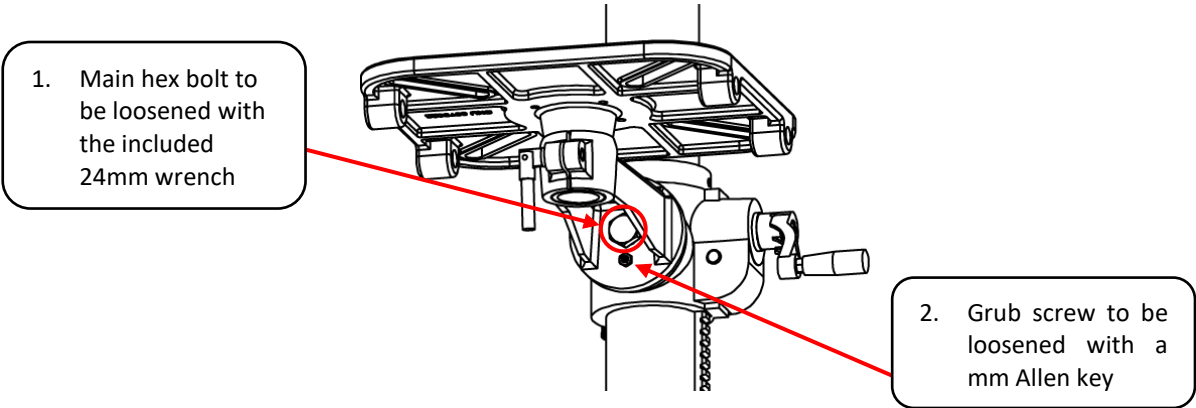

Lock the main table bolt first and then lock the secondary grub screw to secure the table position.

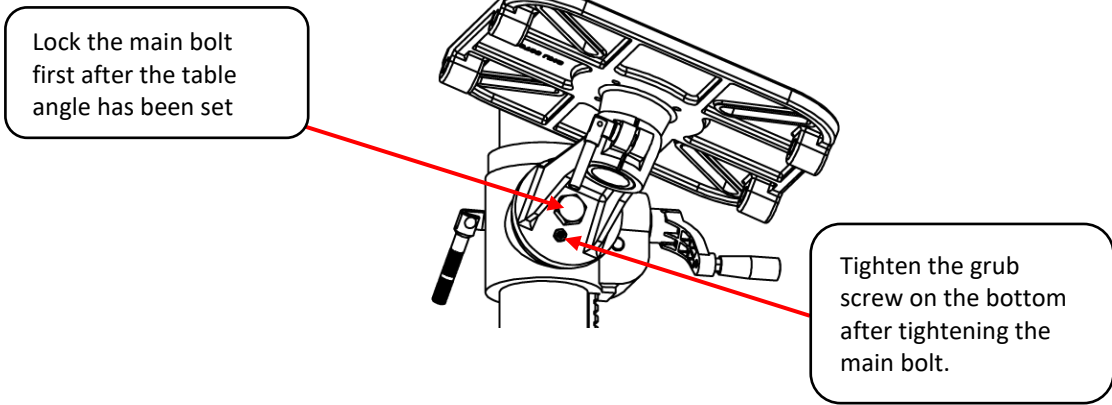

Attaching the Chuck Guard

Note: Only applicable to versions containing the chuck guards at default.

Take the chuck guard out from the packaging and peel off the protective sheet adhered to the guard. Inspect for any defects on the guard.

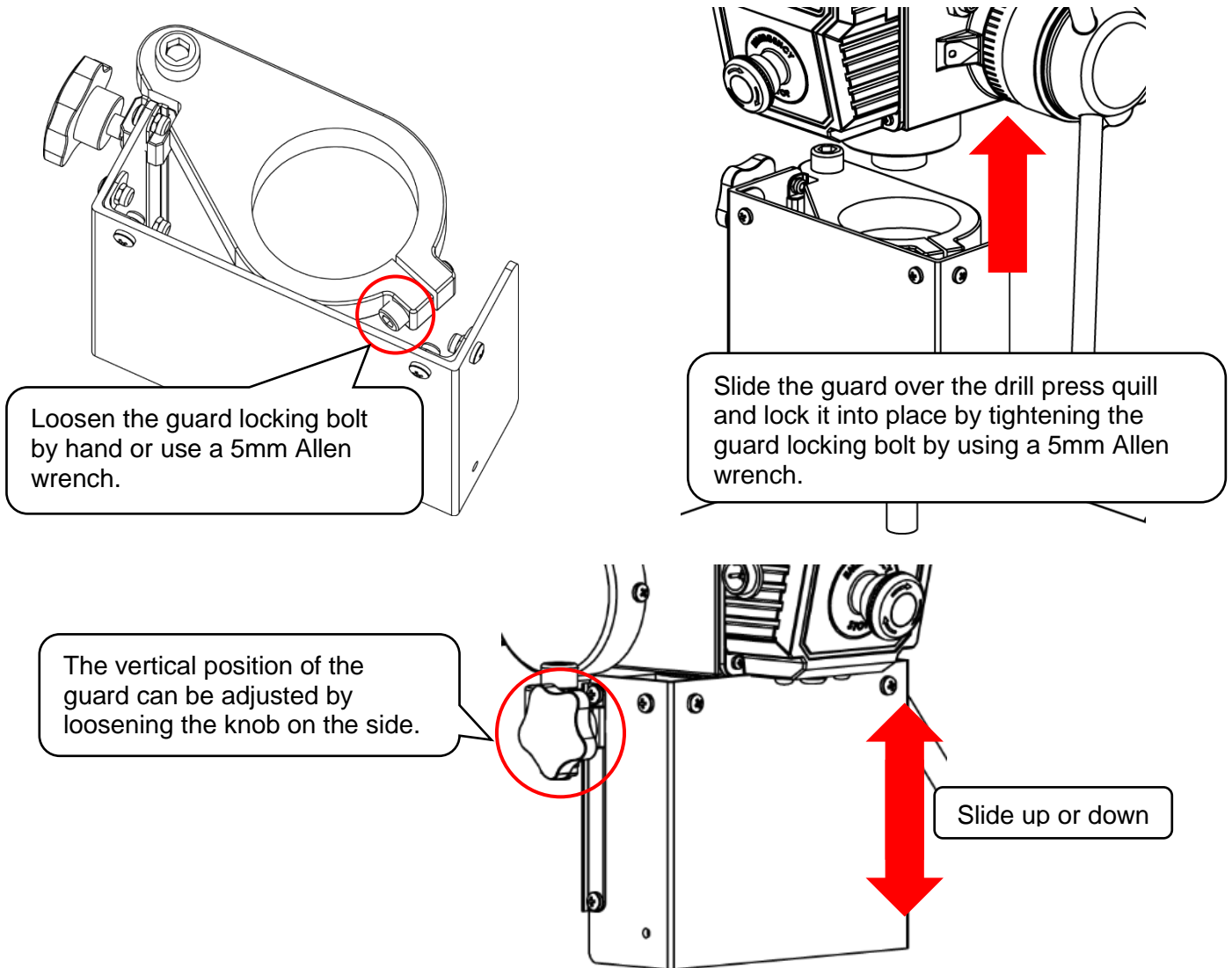

Make sure to have the chuck guard covering the entire chuck.

Connecting to Power



Warning!

Improper power connection may result in a risk of electrical hazard.

Make sure of the following before plugging the NOVA Viking drill press into the power source:

1. The main power switch is turned off
2. Power source is switched off

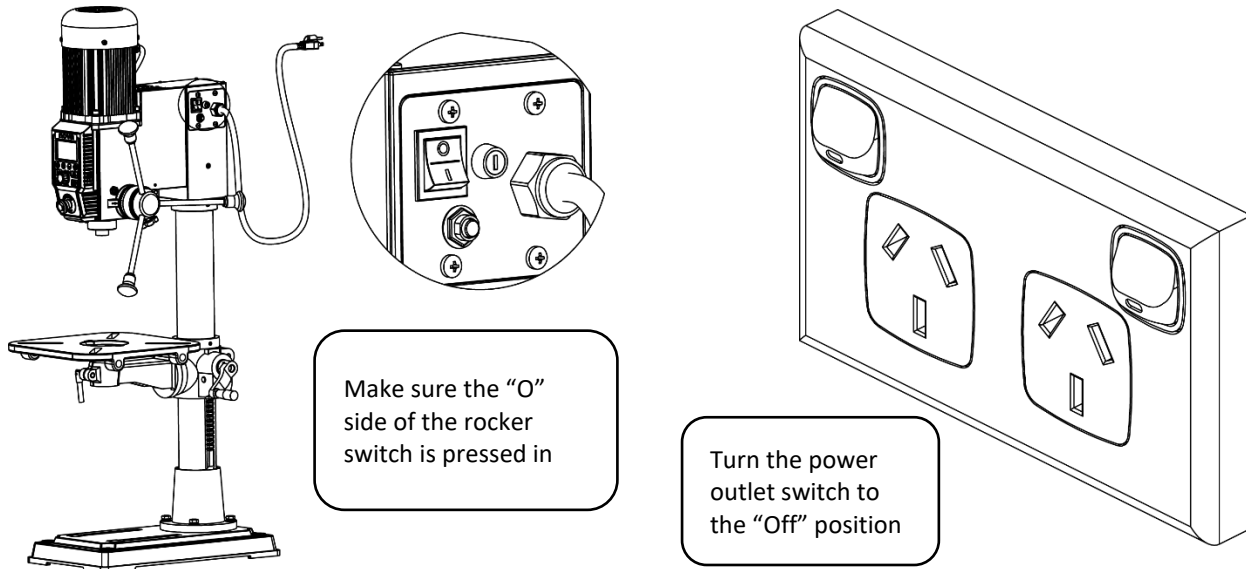

The power cord that is installed on the NOVA Viking drill press will have a three-prong plug which includes a ground prong. The plug must be connected to a matching outlet that is properly installed and grounded in accordance with local electrical codes.

For 115V outlet only:

A temporary adapter can be used to plug into a two-pole outlet if a three-prong outlet is unavailable in your environment. The ground tab on the adapter must be connected to the screw on the outlet for proper grounding. This adapter should only be used until a qualified electrician can install a properly grounded outlet.

Note:

If an extension cable is required, make sure to check the following:

1. Extension cable gauge
2. Is the cable properly insulated?

If in any doubt, please contact your local electrician to inspect the cord according to the local electrical standards before using it.

IMPORTANT:

A surge protection device must be used when using the drill press.

A surge protection device must be rated to at least 15A should be used in countries where 115V are used as a standard. In countries where 240V is used, a surge protector must be rated to either 10A or 15A.

A surge protector with Joules rating of 3900J will be suitable for DVR motors.

Ground Fault Interrupters (GFI)

For a GFI to be compatible with the DVR motor, it must have a **leak current threshold rating of 30mA (0.03A)**

Note:

Normal household GFI will typically be rated at 5mA (0.005A) which may trigger during the operation of the DVR motor. However, frequent tripping of the GFI will not cause any harm to the DVR motor or its control electronics as it has a built-in protective circuit to prevent damage from frequent switching.

Setting up your drill press

Setting up your workshop environment

Your workshop should set up appropriately for you to effectively use the drill press. The workshop should be setup with the following factors taken into consideration:

1. Drill press location

- Locate the NOVA Viking drill press close to a power source in an area with good amount of lighting. Leave enough clearance when the drill press table is swivelled around. Other machines in the workshop should not interfere with the movement/ operation of the drill press.

2. Lighting

- The work shop should have adequate lighting. There should be enough lighting around the drill press not to cast shadows upon the workpiece. If possible, locate the drill press near a window. A portable spotlight might be helpful.

3. Electrical

- The NOVA Viking drill press requires an appropriate power outlet nearby to power the motor. The outlet wiring must meet the local electrical safety standards. If in any doubt, seek advice from an electrician. The length of an extension cable should be reduced as much as possible.

4. Ventilation

- Workshop must have an adequate level of ventilation. The level of required ventilation depends on the size of the workshop and the amount of work that is done within the workshop. The use of dust collectors and filters will minimize your health risk.

Drill Press Interface



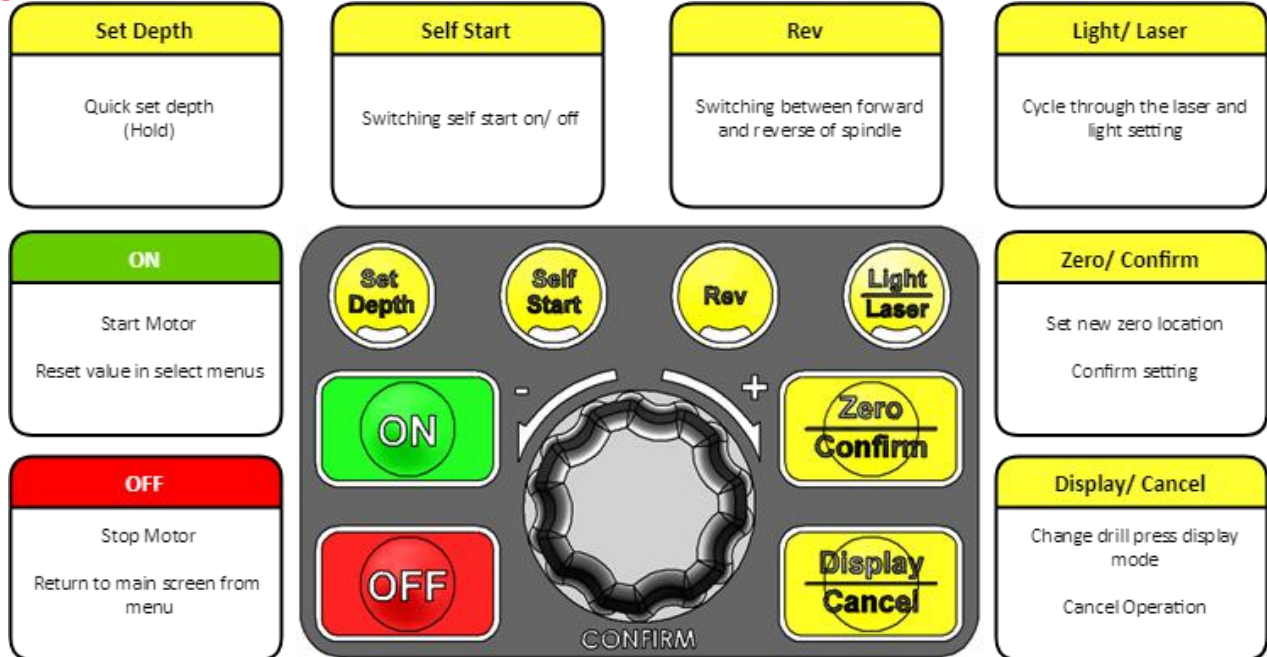



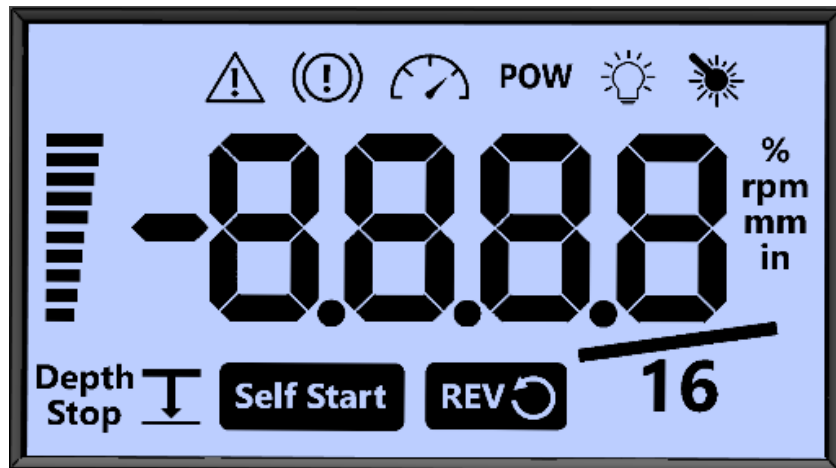

Keypad Buttons



Display Icons



The icons are lit on the screen to indicate various information shown on the screen. The table on the next page explains the definitions of each icons displayed on the screen.

Icon	Description
	The number showed on the screen is spindle setting Speed
POW	The number showed on the screen is Power output percentage
	Light ON
	Laser ON
Depth Stop 	The number showed on the screen is Depth of the spindle
Self Start	Self-Start ON
REV 	Spindle in Rev direction
%	Power output percentage
rpm	Revolutions per minute
mm	Metric
in	Imperial (current default)
	Imperial Fraction Mode
	Customizes bar graph setting (depth bar current default)
	Error warning

Operating the Drill Press

Turning the Drill Press ON

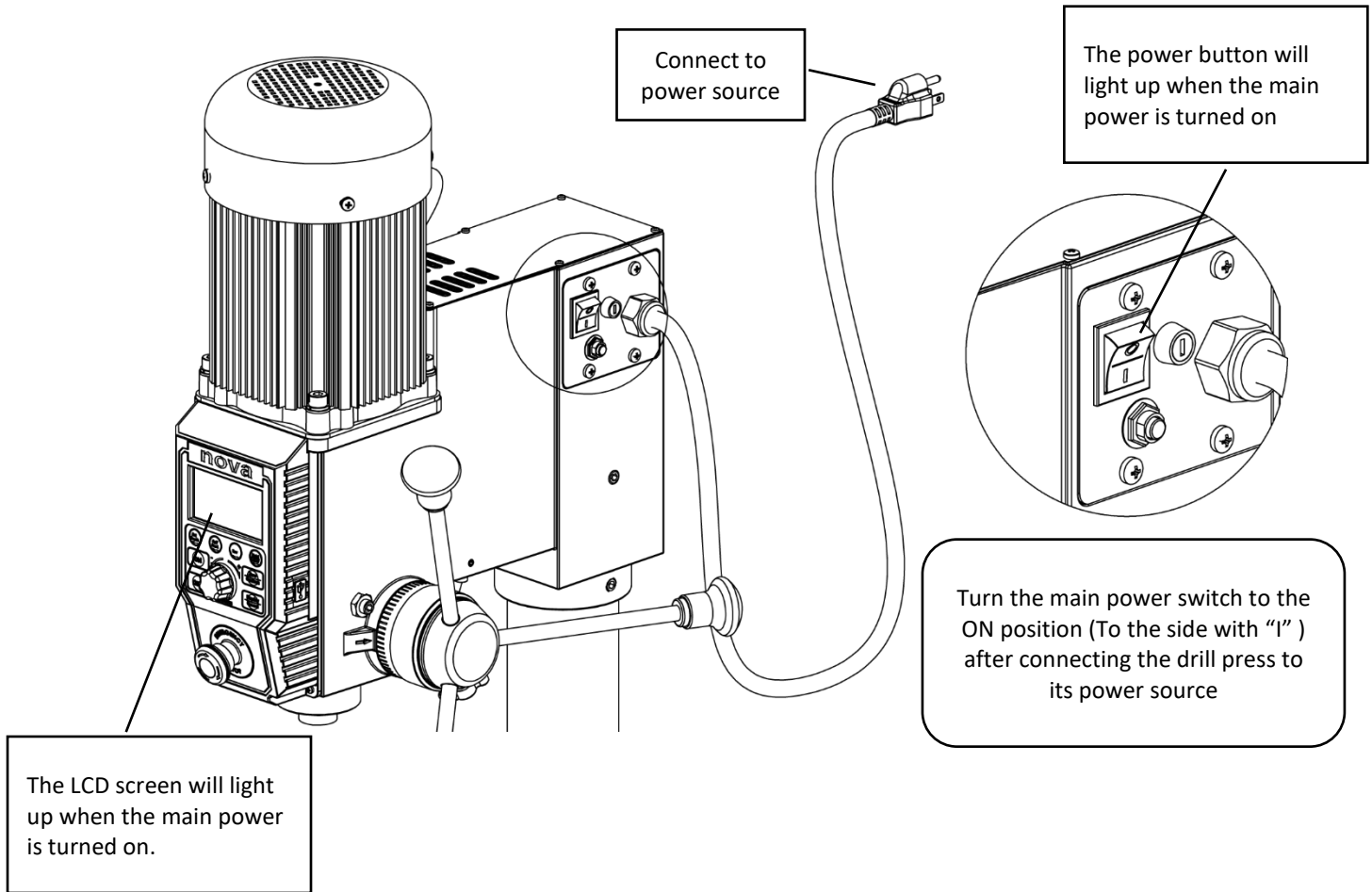

Basic Drill Press Functions

Running the drill press

Press the <ON> button on the interface panel to start the drill press at any time.

Note:

The drill press motor will start running at the speed that it was last set to therefore make sure to check the set speed of the drill press before starting at all times

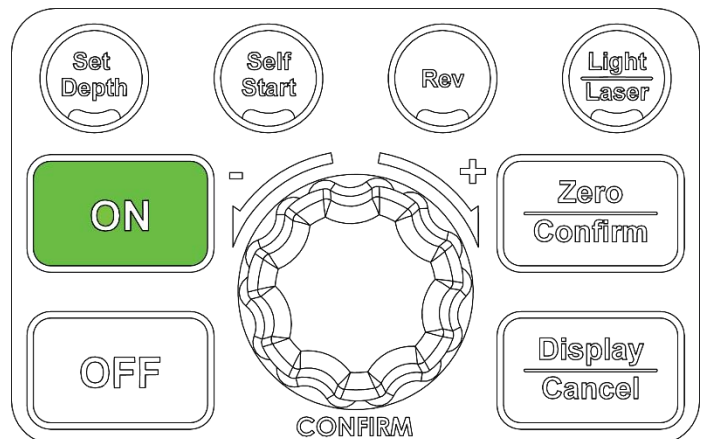

Stopping the drill press

Press the <OFF> button to stop the drill press while it is operational

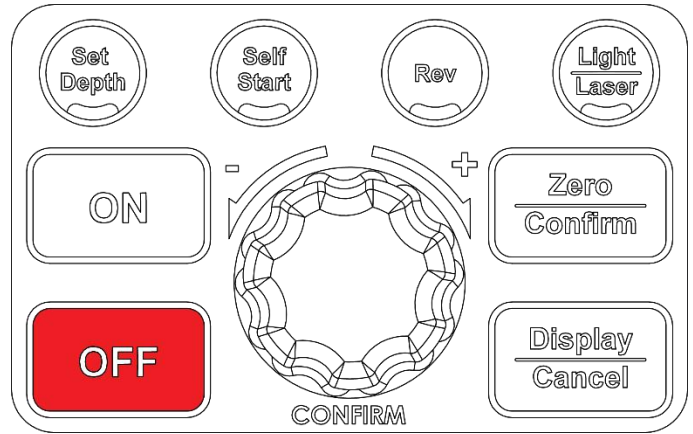

Emergency Stop

Press/ hit the emergency stop switch on the HMI panel to bring the machine to a complete halt.

Note:

The machine cannot be restarted until the emergency stop switch is depressed by twisting it in the clockwise direction.

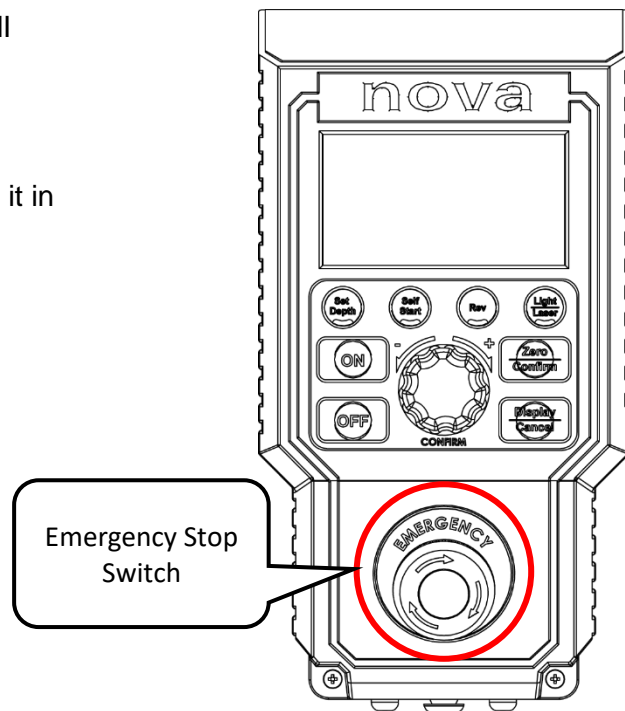

Adjusting the speed

Turn the speed knob to adjust the drill press motor set speed at all times.

Turn the speed knob in the clockwise direction to increase the set speed

Turn the speed knob in the anti-clockwise direction to decrease the set speed

Note:

The drill press set speed can be adjusted at any time while the drill press is turned on. When the set speed knob is turned, the HMI screen will automatically display the current set speed on the drill press.

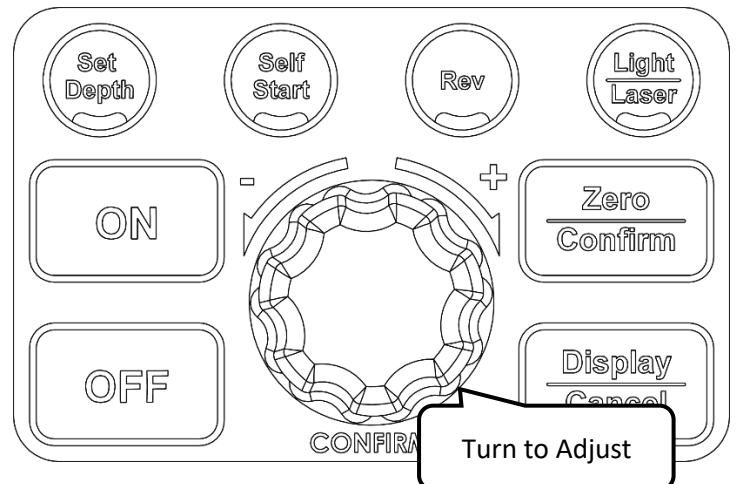

Changing the display mode

Display modes on the NOVA Viking Drill Press

There are 3 display modes available on the NOVA Viking drill press:

1. Depth
2. Speed
3. Power

Press the **<Display/ Cancel>** button to sequentially cycle through each of the available display modes.

The display modes are indicated by the highlighted icons on the HMI screen.

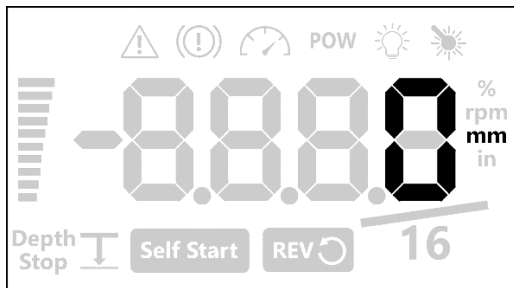
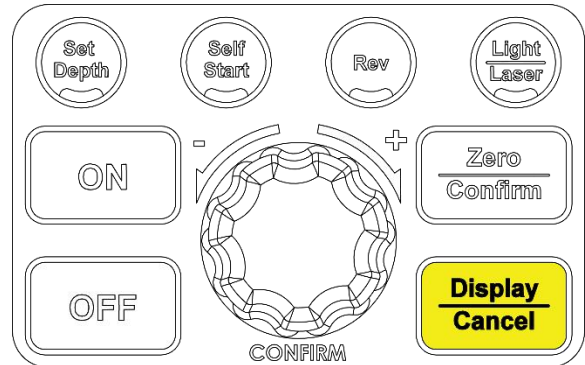

Depth Display Mode (In desired units)

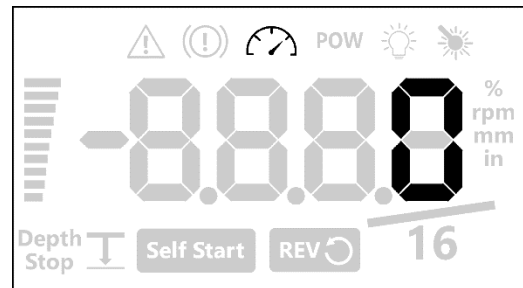

Rotational Speed Display Mode (rpm)

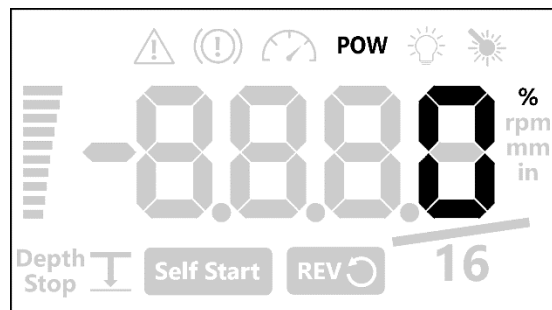

Power usage display mode (%)

Changing the measurement units

Measurement units available on the NOVA Viking Drill Press

There are 3 types of measurement units available on the HMI screen:

1. Imperial decimal – Rounded to 0.005" (default)
2. Imperial fraction – 1/16th inch increments
3. Metric units – Millimetres

Hold down the **<Display/ Cancel>** button for 3 seconds until a beeping noise is heard from the HMI.

Once the beeping noise is heard, the HMI will change the displayed measurement units

The set measurement units will be indicated on the HMI by the highlighted icons

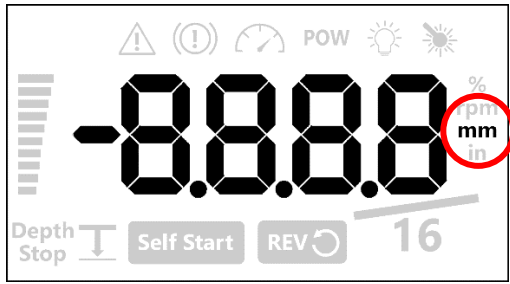

Milimeter depth measurement

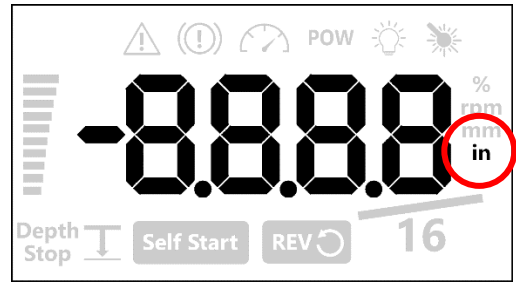

Imperial depth measurement

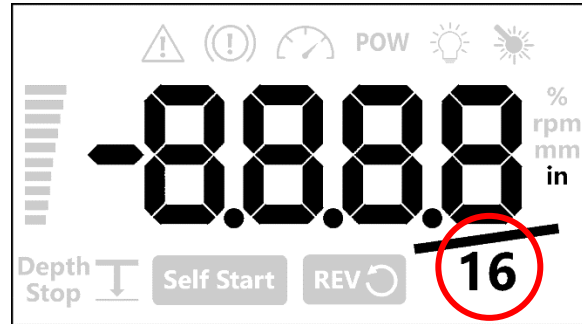

Imperial fraction depth measurement

Switching between forward and reverse

Press the <Rev> button to switch between the forward and reverse mode.

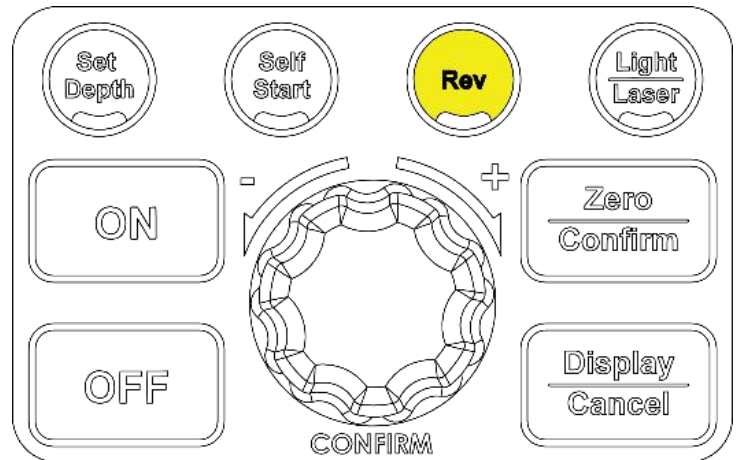

When the drill press is on reversing mode the reverse icon will be highlighted.

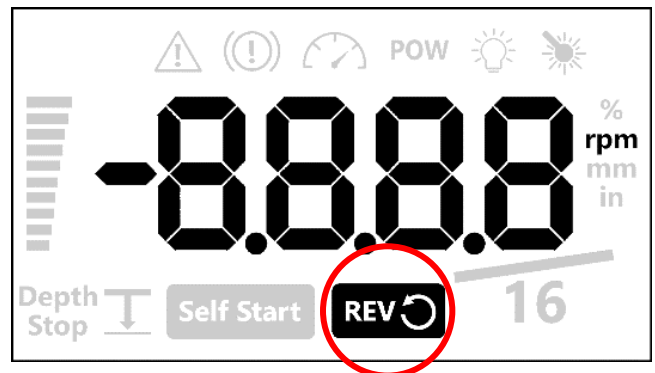

When the drill press is on forward mode, this icon will not be highlighted.

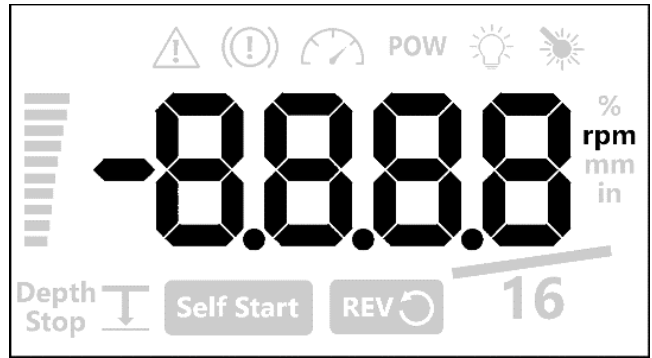

Note:

The forward and reverse mode cannot be switched immediately while the drill press motor is running. Drill press must be completely stationary to switch between forward and reverse operations

Zeroing the depth

This is also known as referencing the depth. This function will let the machine know where to start counting the depth from.

Press the **<Zero/ Confirm>** button to zero the depth reading on the drill press.

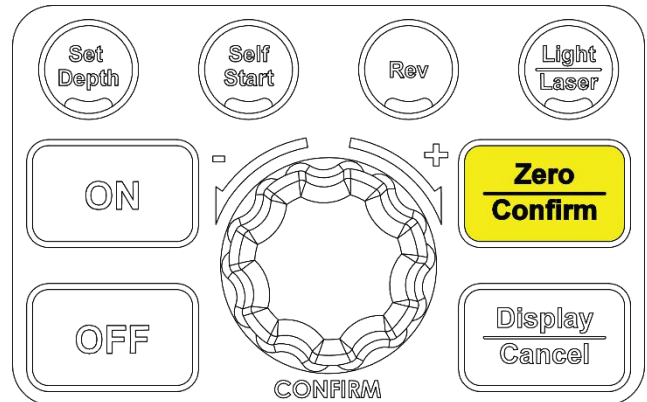

The depth read out will be set to zero at the current extension of the quill.

E.g. If the quill is extended by 20mm and when the depth read out is zeroed, the depth will start counting positive from the 20mm position.

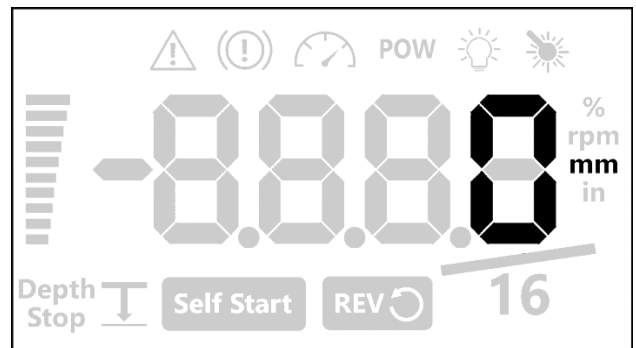

Using the light and lasers



Available laser and light modes

There are 3 laser and light modes available on the NOVA Viking drill press:

1. Both laser and light on
2. Laser on and light off
3. Laser off and light on

Press the **<Light/ Laser>** button to cycle through each of the available modes on the NOVA Viking drill press.

Each of the modes can be identified as the icons will be highlighted to indicate which function is turned on.

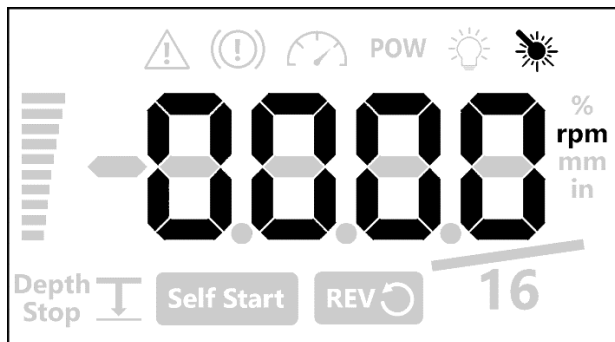
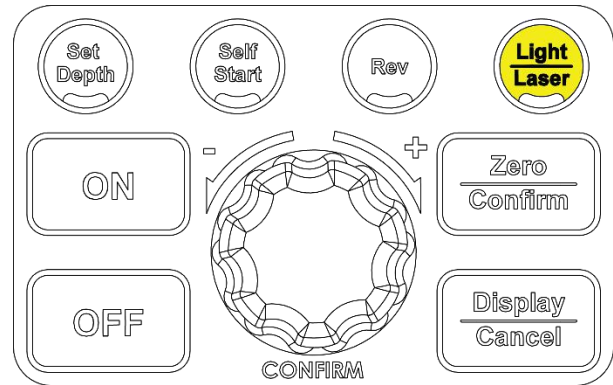

Laser on

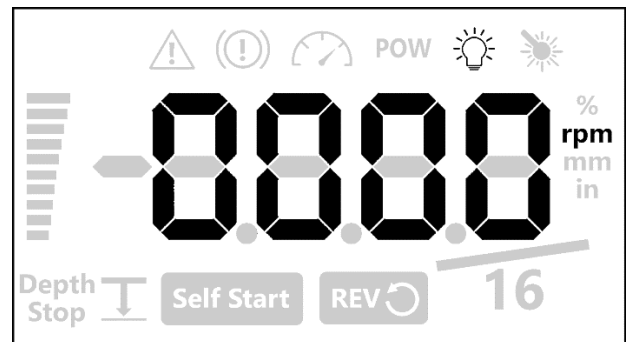

Light on

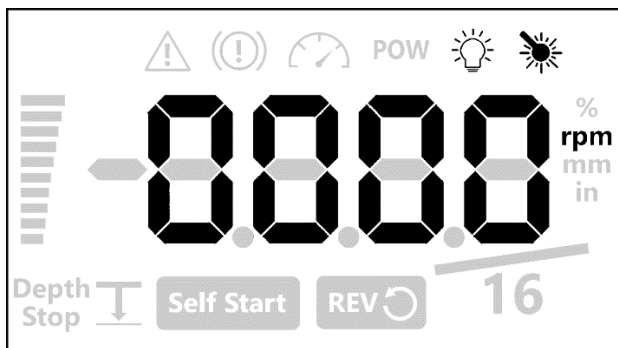

Laser and light on

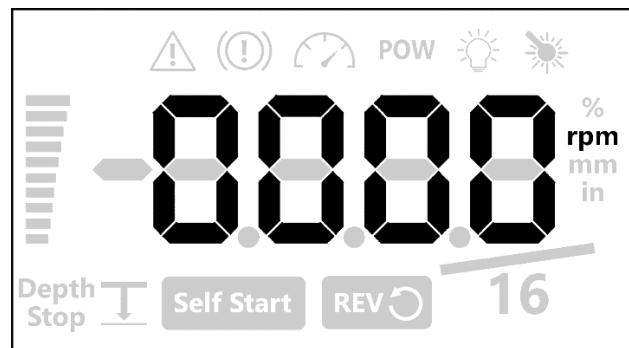

Both off

The laser not accurately aligning?
Refer to **<page 33>** on how to adjust the laser modules

Intermediate Functions

Using the electronic depth stop function

Setting the stop depth value

Press the **<Set Depth>** button to enter the set depth mode of the drill press. In this mode, the Depth Stop icon will be blinking.

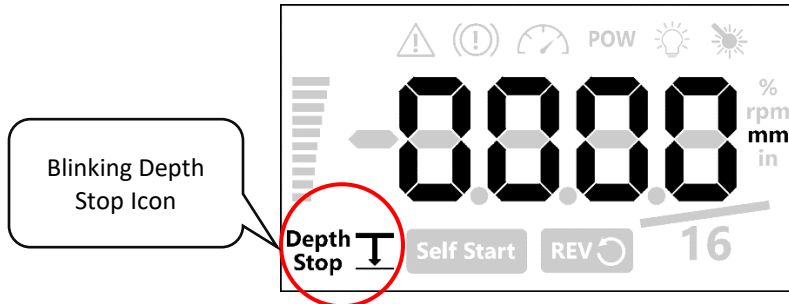
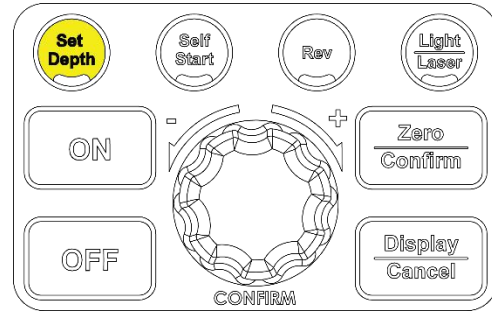

Set the desired depth (measured in the selected units) by turning the speed knob in the clockwise direction to increase the set depth that is displayed on the screen.

Turn the speed knob in the anti-clockwise direction to increase the set depth that is displayed on the screen.

Note:

Turn the speed knob for a fine adjustment.
Press and turn the speed knob for a coarse adjustment

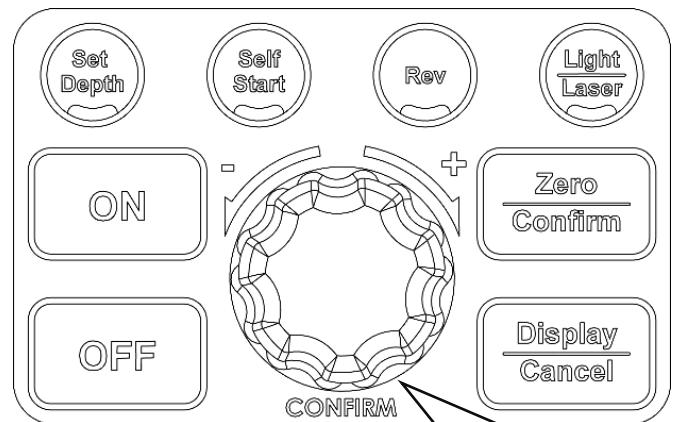

Once the set depth entered on the screen

Save the set depth value

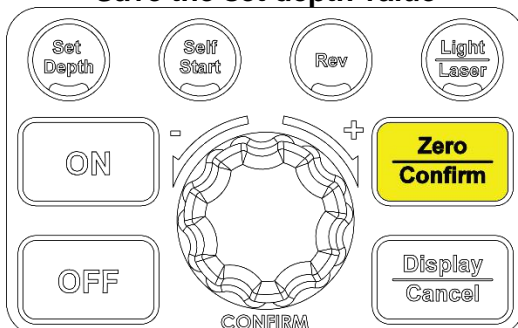

Press the **<Zero/ Confirm>** button once the desired depth is entered on the screen to save the set depth. The depth stop icon will stay lit if the set depth value is saved successfully.

Cancel and Return

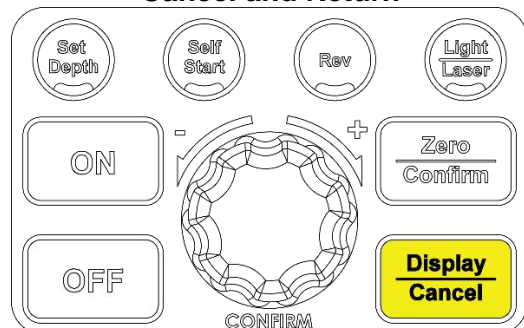

Press **<Display/ Cancel>** button to return to the default screen without saving.

Quick Set Depth Function

This function provides a faster method to set the depth stop value however, it may be difficult to set the exact desired depth value with this function.

Extend the drill press quill down to the point where it displays the desired depth value.

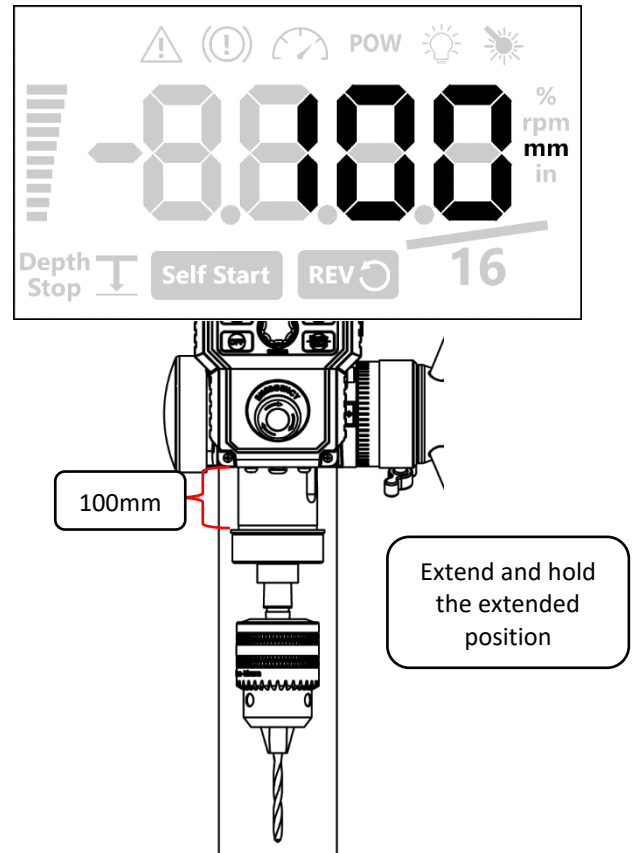

Press and hold the <Set Depth> button for 3 seconds while holding the quill in its position. The HMI will beep and it will automatically save the value that is displayed on the HMI screen as the set depth.

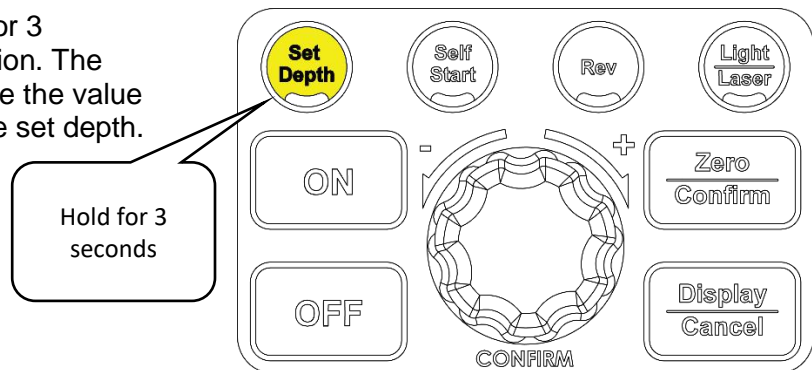

Note:

The quick depth stop function will save the exact value that is being shown on the screen. The value will not be rounded when it is being saved therefore a more precise setting can be achieved quickly with this function.

Using this quick set function while the height is within 5mm (1/5") from the top position will turn off the set depth function.

Electronic Depth Stop Function

Once the stop depth value is specified and saved onto the machine, the electronics depth stop function is activated.

The activation of the electronic depth stop function is indicated by the icon on the HMI screen shown below:

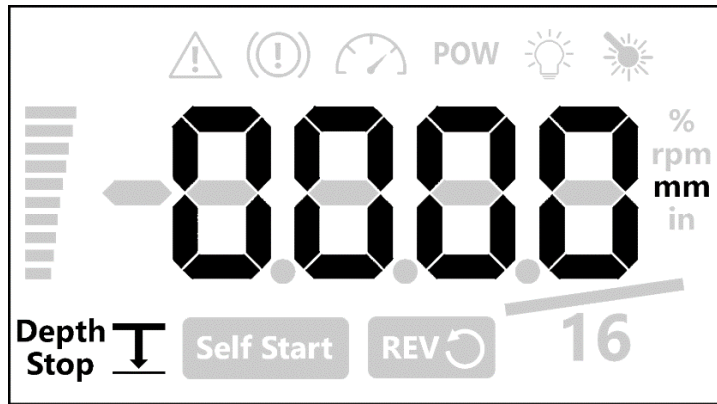

As the drill press readout approaches the set depth, the drill press screen will start to blink and HMI will start to beep.

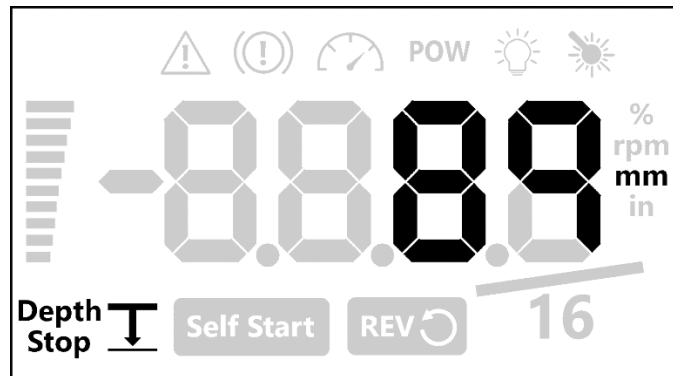

HMI Screen flashes as the displayed depth approaches the set depth
+ Beeping Sound

Note:

The screen blinking and beeping frequency will become faster as the depth read out becomes closer to the set depth value.

Drill press will stop when the drill press depth reading reaches the set depth value. To change the drill press behaviour when the set depth is reached can be changed refer to <page 28>

Using the Self-Start Function

Press the <Self Start> button to activate the self-start function.

Press the <Self Start> button to deactivate the self-start function

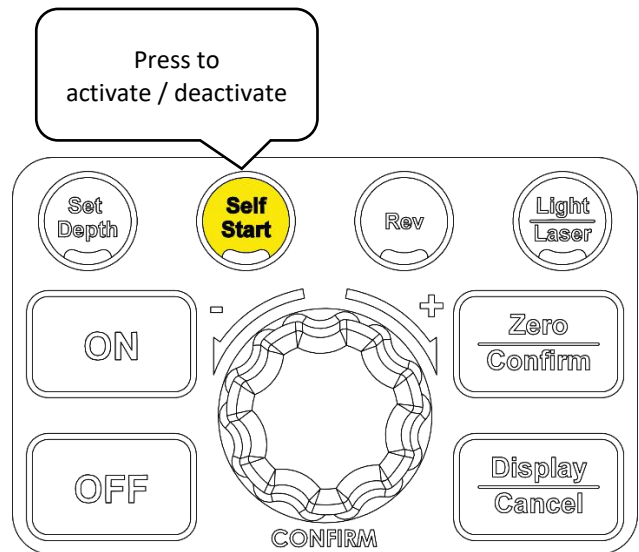

The activation of the self-start function is indicated by the self-start icon on the bottom of the HMI display

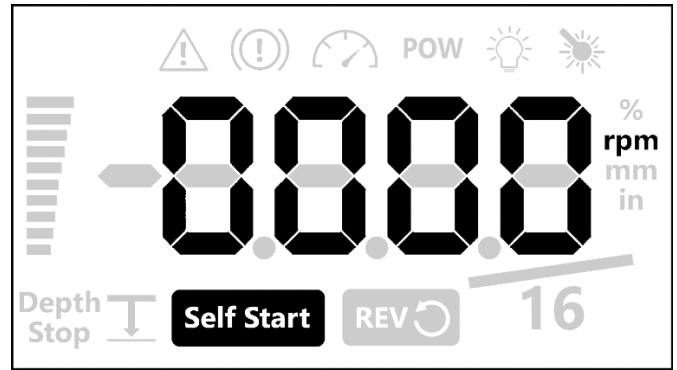

Note:

The self-starting depth is approximately 7mm from the top. This value is based on the absolute sensor readout value therefore the threshold value will not be affected by any depth value offset made by the user. The drill press will stop once the quill has been retracted back to 6mm depth.

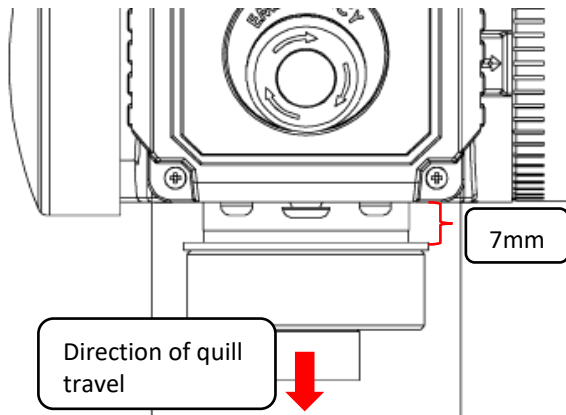

Motor automatically start with self start function

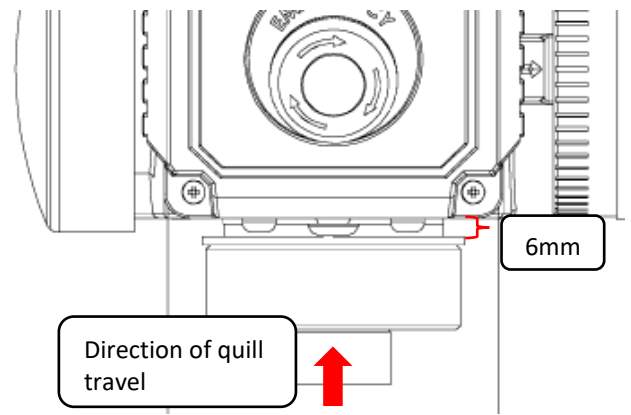

Motor automatically stops with self start function

Power Spindle Hold Function

Press and hold the <ON> button on for 3 seconds while the motor is on idle.

The drill press will apply 8% power on the motor to lock the spindle in position for 30 seconds.

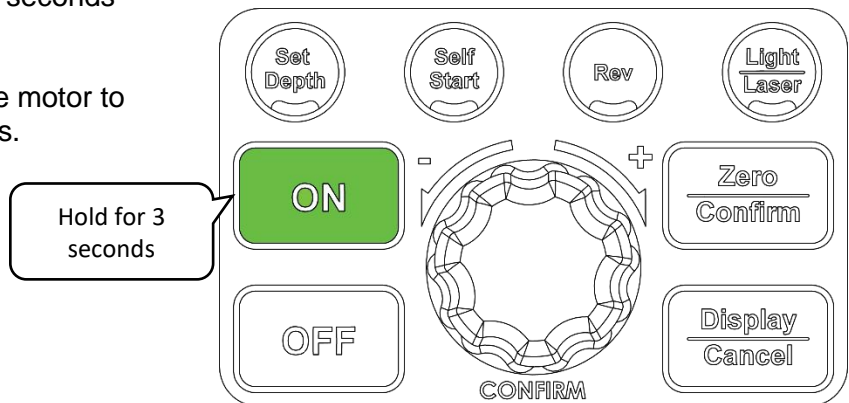

Note:

This function is to allow easy hand tightening of a keyless chuck

Advanced Functions

Performing a Factory Reset

Press and hold the <Self Start> button and then press the <OFF> button.

Note:

Do not release the <Self Start> button.

Hold the <Self Start> button for another 1~2 seconds and then release.

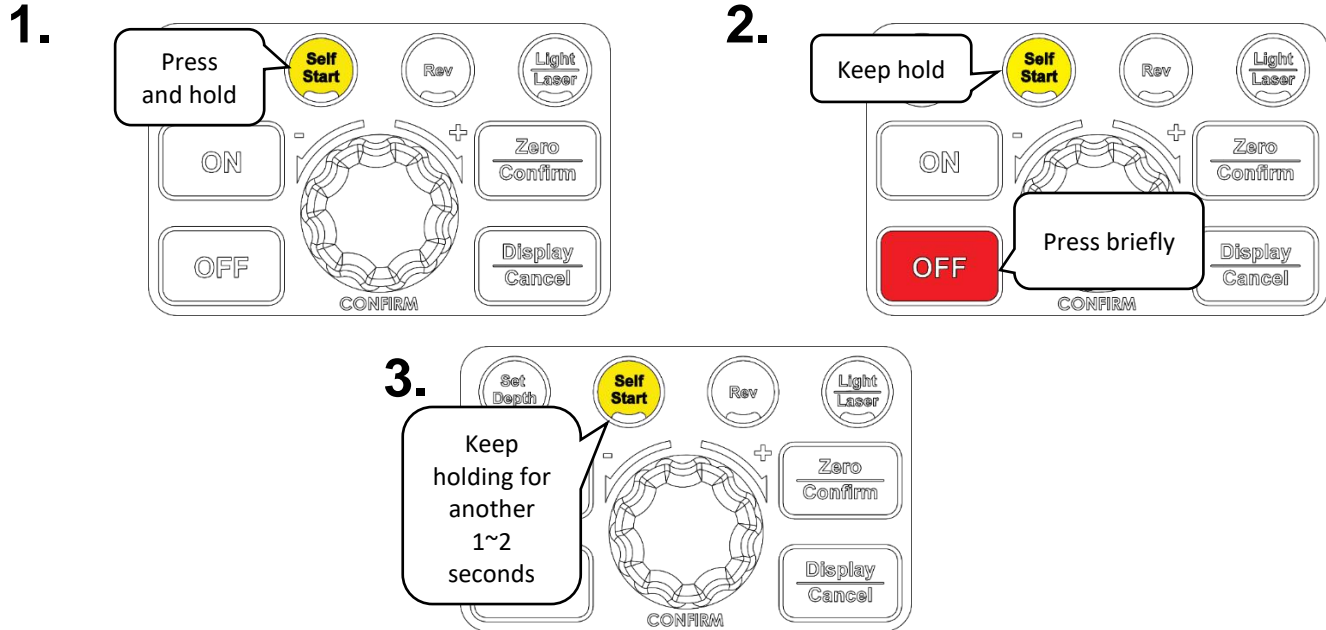

The factory reset will also reset the Self Start Depth threshold

Turning the sound on or off

Press and hold the <Rev> button and press the <OFF> button.

Note:

Do not release the <Rev> button.

Hold the <Rev> button for another 1~2 seconds.

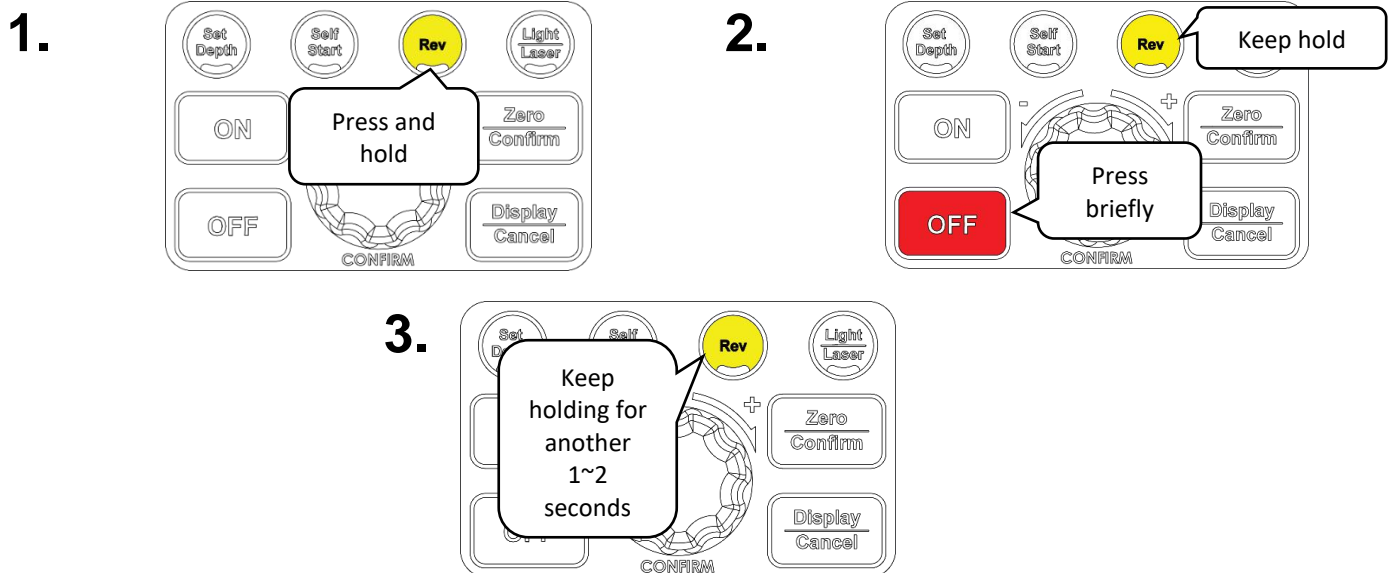

The screen will flash once and a “Sound On” or “Sound Off” message will flow from left to right on the LCD when the command is successfully executed.

The displayed text will indicate the current sound setting of the machine.

Changing the power bar settings

Press and hold the <Light/ Laser> button and press the <OFF> button.

Note:

Do not release the <Light/ Laser> button.

Hold the <Light/ Laser> button for another 1~2 seconds.

1.

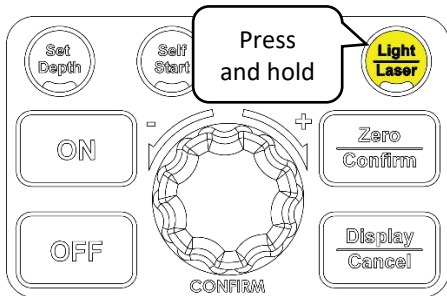

2.

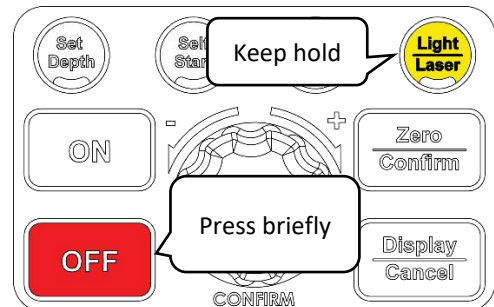

3.

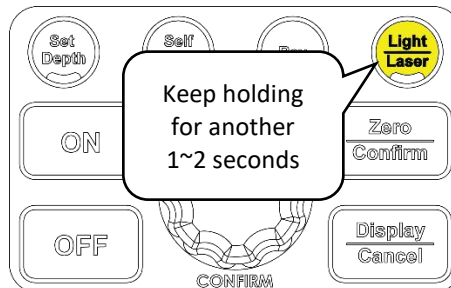

The HMI screen will display one of the following texts depending on mode which the machine is set at:

1. Depth bar
2. Load bar
3. Bar off

Calibrating the Height Sensor Drill Press

Press and hold the **<Zero/ Confirm>** button and press the **<OFF>** button.

Note:

Do not release the **<Zero>** button.

Hold the **<Zero/ Confirm>** button for another 1~2 seconds.

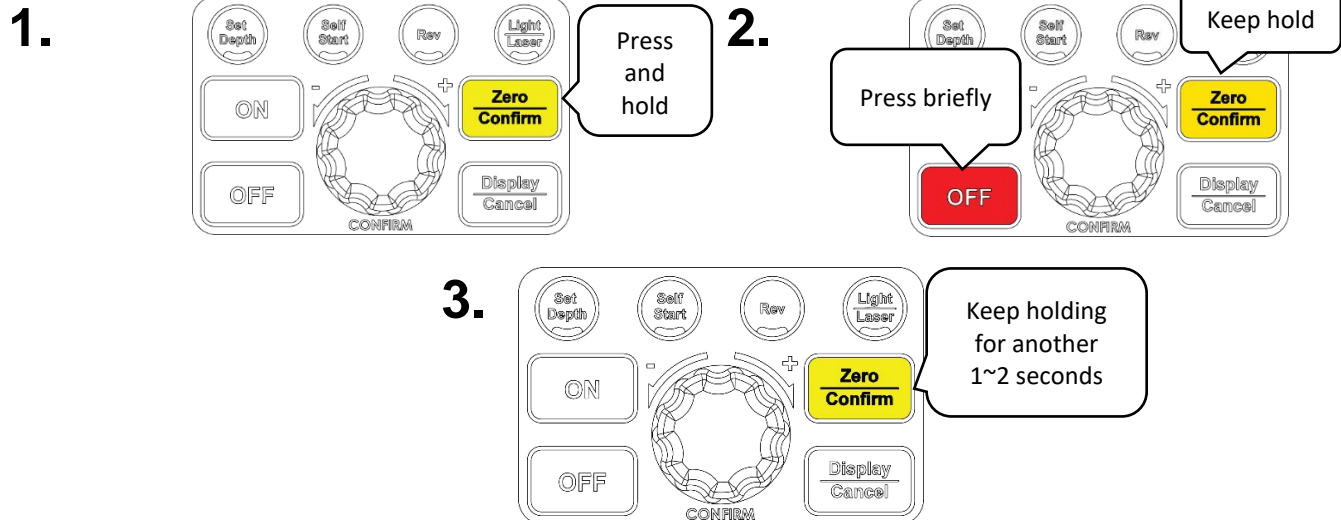

The HMI screen will display a “C” and then a certain depth on the screen.

Extend the drill press quill to the depth that is being displayed on the screen.
Press **<Set Depth>** button to calibrate at the specified depth.

Unlocking the drill press speed range to 6000rpm

The NOVA Viking drill press can achieve a maximum operation speed of up to 6000rpm (default setting at 3000rpm). This speed is ideal for metal working purposes where it requires very fast rotation speeds

Press and hold the **<Display/ Cancel>** button and press the **<OFF>** button.

Note:

Do not release the **<Display/ Cancel>** button.

Hold the **< Display/ Cancel>** button for another 1~2 seconds.

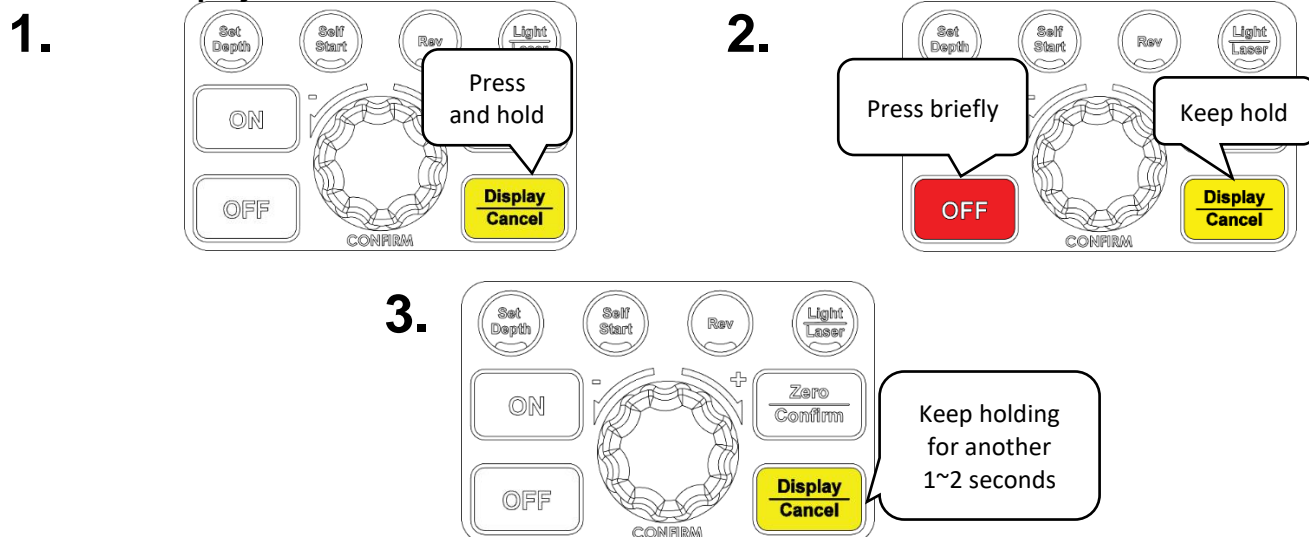

Changing the drill press depth stop behaviour

The NOVA Viking drill press has 3 different type of behaviour when the set depth is reached during the activation of the depth stop function:

1. Stop at set depth
2. Stop and reverse for 3 seconds (Default)
3. Stop and reverse until the quill reaches the top.

To change this drill press behaviour:

Press and hold the **<ON>** button and press **<OFF>**.

This will sequentially cycle through the options

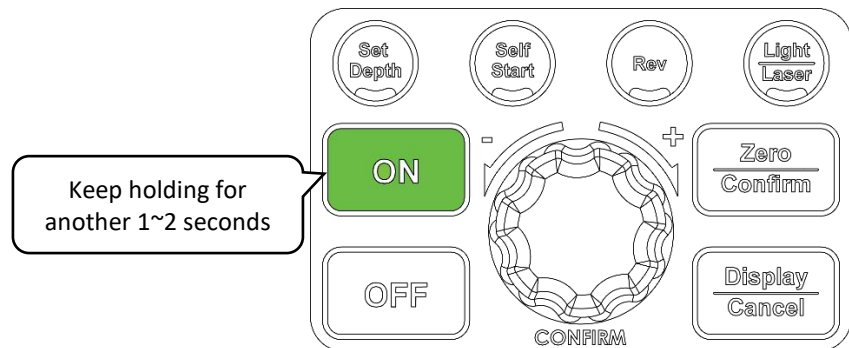
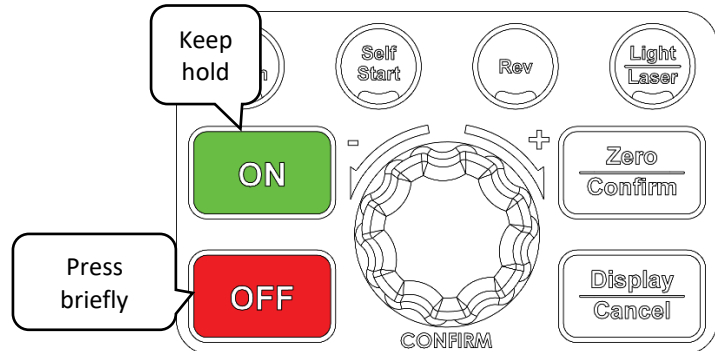
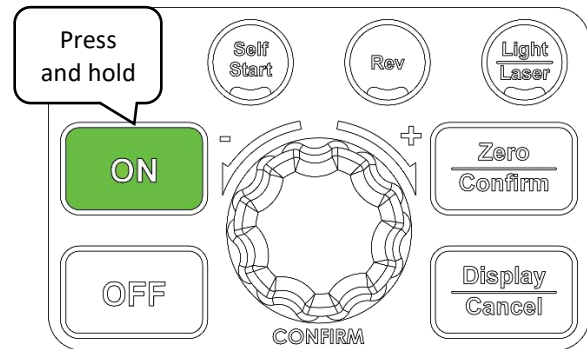

Maintaining your Drill Press

Regular maintenances are essential when considering the long-term use of the drill press.



Warning!

Always isolate the drill press from its power source before carrying out any maintenance procedure

Maintenance after each use

1. Clean the work area and drill press
2. Vacuum shavings and dust from the headstock, table and base

Monthly maintenance

1. Wax coat the exposed cast iron parts with a good quality paste wax. Buff off thoroughly.
2. Check tightness of nuts and bolts
3. Clean all tapers to ensure a secure fit

6month Maintenance

1. Lubricate the gear and the rack in the table elevation mechanism, spindle splines and grooves on the quill with a #2 tube grease
2. Lubricate the teeth of the feed shaft assembly and quill shaft with one or two drops of light weight oil.

Speed Chart for Metal Drilling

The NOVA Viking DVR drill press is capable of handling both metal and wood work due to the high-power DVR motor. Table below shows the reference speed when cutting into different metals with a twist drill bit.

Material		Cast Iron		Mild Steel		Aluminium & Copper	
Tool Diameter		Feed Rate					
		m/min	Ft/min	m/min	Ft/min	m/min	Ft/min
mm	Inch	Cutting Speed [RPM]					
2	1/16	3820	4890	4775	6000	6000	6000
3	1/8	2545	2445	3185	3055	6000	6000
5	3/16	1530	1630	1910	2035	3820	4075
6	1/4	1275	1220	1590	1530	3180	3055
8	5/16	955	980	1195	1220	2390	2445
10	3/8	765	815	955	1020	1910	2035
11	7/16	700	700	870	870	1740	1745
13	1/2	590	610	735	765	1470	1530
16	5/8	480	490	600	610	1200	1220
19	3/4	380	405	480	510	955	1020

The speeds highlighted requires the drill press to be unlocked to its high-speed drilling mode

Refer to page24 to unlock speed for high speed metal drilling functions

Note:

These speeds are based on High Speed Steel (HSS) cutting tools. Cutting speeds and feed rate will vary between different tool materials.

Full Speed Chart for General Materials

Below is the speed chart showing the speed charts for different type of drill bits and materials.

Table areas highlighted in red are the areas are the areas not recommended

Bit Type	Tool Diameter		Material						
			Soft Wood	Hard Wood	Acrylic	Brass	Aluminium	Steel	Glass/ Tile
	Metric [mm]	Imperial [in]	Spindle Speed [RPM]						
Twist Drill	1 ~ 5	1/16 ~ 3/16	3000	3000	2500	3000	3000	3000	NA
	6 ~ 10	1/4 ~ 3/8	3000	1500	2000	1200	2500	1000	NA
	11 ~ 16	7/16 ~ 5/8	1500	750	1500	750	1500	600	NA
	17 ~ 25	11/16 ~ 1	750	500	NA	400	1000	350	NA
Brad Point	3	1/8	1800	1200	1500	NA	NA	NA	NA
	6	1/4	1800	1000	1500	NA	NA	NA	NA
	10	3/8	1800	1250	1500	NA	NA	NA	NA
	13	1/2	1800	1250	1000	NA	NA	NA	NA
	16	5/8	1800	500	1250	NA	NA	NA	NA
	19	3/4	1400	250	1250	NA	NA	NA	NA
	22	7/8	1200	250	500	NA	NA	NA	NA
	25	1	1000	250	250	NA	NA	NA	NA
Bullet Pilot Point	3 ~ 5	1/8 ~ 3/16	3000	3000	3000	2000	1500	3000	NA
	6 ~ 10	1/4 ~ 3/8	3000	3000	2400	1500	1000	2000	NA
	13	1/2	3000	1500	1600	1500	750	1200	NA
Spade Bits	6 ~ 13	1/4 ~ 1/2	2000	1500	NA	NA	NA	NA	NA
	16 ~ 25	5/8 ~ 1	1750	1500	NA	NA	NA	NA	NA
	29 ~ 38	1 1/8 ~ 1 1/2	1500	2000	NA	NA	NA	NA	NA
Spade Bits with Spur	10 ~ 25	3/8 ~ 1	2000	1800	500	NA	NA	NA	NA
Hole Saw	25 ~ 38	1 ~ 1 1/2	500	350	NA	250	250	NA	NA
	41 ~ 51	1 5/8 ~ 2	500	250	NA	150	250	NA	NA
	54 ~ 64	2 1/8 ~ 2 1/2	350	100	NA	150	250	100	NA
Circle Cutter	38 ~ 76	1 1/2 ~ 3	500	250	250	NA	NA	NA	NA
	83 ~ 203	3 1/4 ~ 8	250	250	250	NA	NA	NA	NA
Forstner	6 ~ 10	1/4 ~ 3/8	2400	800	NA	NA	NA	NA	NA
	13 ~ 16	1/2 ~ 5/8	2400	500	250	NA	NA	NA	NA
	19 ~ 25	3/4 ~ 1	1500	500	250	NA	NA	NA	NA
	29 ~ 32	1 1/8 ~ 1 1/4	1000	250	250	NA	NA	NA	NA
	35 ~ 51	1 1/8 ~ 2	500	250	NA	NA	NA	NA	NA
	54 ~ 102	2 1/8 ~ 4	250	250	NA	NA	NA	NA	NA
Power Bore	6 ~ 13	3/8 ~ 1/2	1800	500	NA	NA	NA	NA	NA
	19 ~ 25	3/4 ~ 1	1800	750	NA	NA	NA	NA	NA
Shear Cutting Countersink	6 ~ 10	1/4 ~ 3/8	1000	1000	700	850	850	NA	NA
Countersink	2 Flute		1400	1400	NA	NA	NA	NA	NA
	5 Flute		1000	750	750	250	250	250	NA
Glass and Tile	3	1/8	NA	NA	NA	NA	NA	NA	750
	5	3/16	NA	NA	NA	NA	NA	NA	600
	6	1/4	NA	NA	NA	NA	NA	NA	500
	8	5/16	NA	NA	NA	NA	NA	NA	400
	10	3/8	NA	NA	NA	NA	NA	NA	350
	13	1/2	NA	NA	NA	NA	NA	NA	20

Note: The speeds shown on the table is a general guide line. Drill press speed should always be determined from the experience of the user and conditions.

Firmware Update

The HMI software plays an important role in the control and functionality of the NOVA Viking Drill Press. The firmware loaded onto the HMI panel is responsible of controlling the features and performance of the drill press.

The firmware version of the HMI can be upgraded via the included USB cable accessory and a PC with internet access. Be sure to check www.teknatool.com periodically for firmware upgrades for your machine, which may allow new features or software improvements that could enhance the performance of the drill press.

Checking the firmware version

Follow the instructions below to check the firmware version that is currently loaded on the drill press:

Press and hold the **Speed dial** and press the **<OFF>** button.

Note:

Do not release the **Speed dial**

Hold the **Speed dial** for another 1~2 seconds.

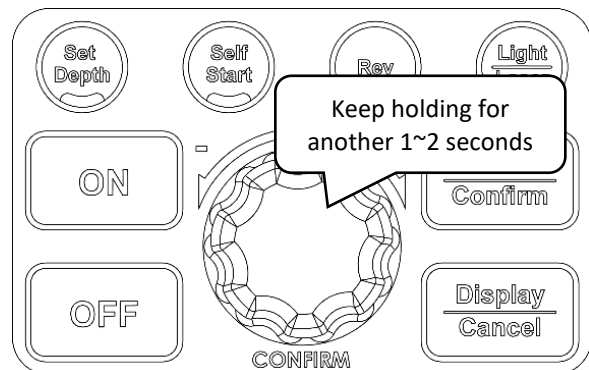
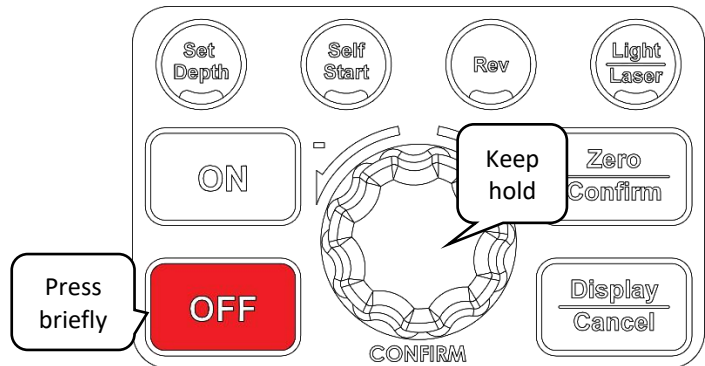
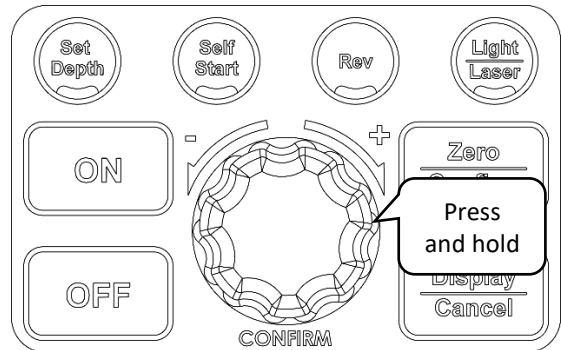

Once the command has been entered successfully, the drill press will begin to display the interface firmware version number and the main control board version number in the respective sequence.

USB Mode

When updating the HMI Firmware, HMI must be put into USB mode for it to perform the update

1. Turn off the drill press
2. Download and install the NOVA firmware update software from our website under the following URL:
<https://www.teknatool.com/product/nova-voyager-firmware-upgrade/>

Note: This software is only compatible with Windows Operating Systems

3. Remove the rubber cap from the USB port located on the right side of the HMI panel.
4. Plug the USB cable into the HMI panel and wait for approximately 5 seconds until the screen shows “USB”

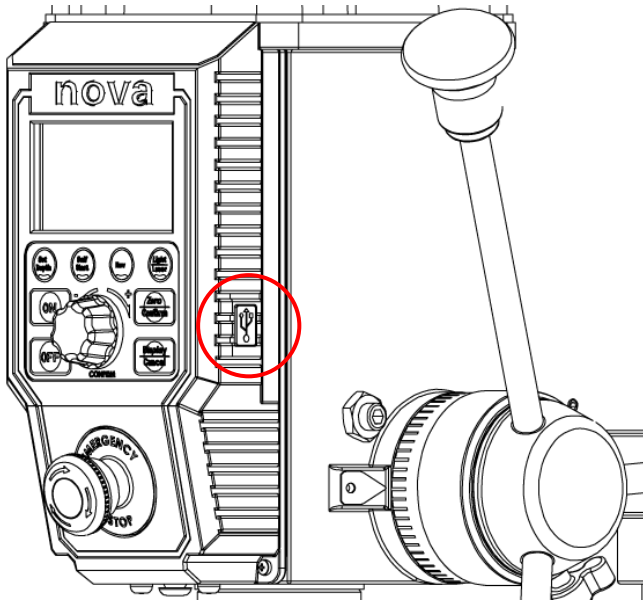

Location of the USB port on the HMI Panel

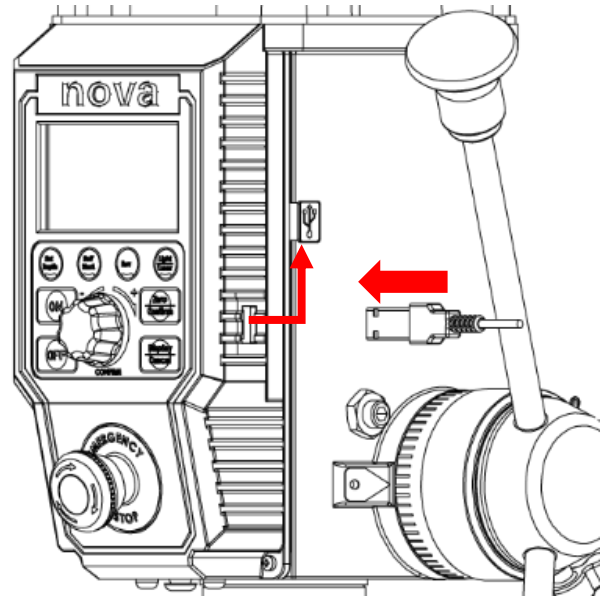

Insert the long side of the included USB A-A cable

Note:

The included USB A – A cable is not a standard cable

Troubleshooting

Mechanical Issue

Symptom	Place to check	How to resolve
The attached tool does not run true	<ol style="list-style-type: none"> 1. Inside the drill press spindle 2. Morse Tapered tool/ arbour 3. Chuck 4. Attached tool <p>Note: The NOVA specification of the axial runout is: ±0.02mm on Spindle Morse Taper ±0.04mm on end of arbour ±0.18mm on end of 100mm straight rod attached to a chuck.</p>	<p>The solution will differ based on where the run out is detected at:</p> <ol style="list-style-type: none"> 1. Inside the drill press spindle <ul style="list-style-type: none"> - The entire spindle assembly should be replaced 2. Morse Tapered tool/ arbour <ul style="list-style-type: none"> - Make sure all the contacting surfaces are cleaned - If the tool still has runout after all surfaces has been cleaned, try changing the tool to another one. 3. Chuck <ul style="list-style-type: none"> - Replace the chuck to another 4. Attached tool <ul style="list-style-type: none"> - Make sure the tool is mounted on the chuck correctly. <p>Note: When checking the cause of the runout, always make sure to check from the spindle.</p>
Quill does not retract back	<ol style="list-style-type: none"> 1. Return spring 2. Quill and quill housing <ul style="list-style-type: none"> - Make sure all surfaces are lubricated sufficiently without excess contaminants. 3. Handle pinion gear <ul style="list-style-type: none"> - Make sure all contacting surfaces are covered with sufficient amount of lubricants. 	<p>Note: Support the quill to make sure it does not fall out from the headstock.</p> <ol style="list-style-type: none"> 1. Carefully release the locking bolt from the return spring housing and hand tighten by rotating it in the anti-clockwise direction. Lock the spring housing by using the locking bolt before releasing. 2. Extend the quill as far as possible and apply lubricant of relatively high viscosity. Move the quill up and down a couple of times to spread the lubricant. 3. Remove the handle spring and release the locking set screws to extract the handle from the headstock. Apply lubricants on all contacting surfaces and then reassemble everything back together.

<p>Laser not aligning with the drill bit</p>	<ol style="list-style-type: none"> 1. Drill bit <ul style="list-style-type: none"> - Make sure the drill bit is not damaged and is mounted onto the chuck correctly. 2. Chuck and arbour <ul style="list-style-type: none"> - Check to see if there are any misalignments when mounting the chuck onto the arbour or the arbour onto the quill. 3. Laser module positioning <ul style="list-style-type: none"> - If factor 1&2 are confirmed to having no alignment issues, the laser module position should be adjusted. 	<p>Secure a test work piece onto the drill press table by any method (clamp, bolt, etc)</p> <ol style="list-style-type: none"> 1. Using a small drill bit (typically about $\Phi 3\text{mm}$) drill a hole into the mounted work piece. 2. Turn the laser modules on. <u>Warning: Do not look directly into the laser</u> 3. Loosen the grub screws located on the side of the headstock. 4. Adjust the angle of the laser module so it intersects at the marked point. 5. Tighten the grub screw back to lock the lase modules into place.
<p>Excessive vibration during operation</p>	<ol style="list-style-type: none"> 1. Workpiece mounting <ul style="list-style-type: none"> - Check to see if workpiece is securely mounted. 2. Drill press base connection security <ul style="list-style-type: none"> - Check if the drill press base connection is secure. 3. Bench where the drill press is mounted on. 4. Drill bit <ul style="list-style-type: none"> - Check if the drill bit is blunt or not 5. Incorrect drilling speed 	<ol style="list-style-type: none"> 1. Make sure to securely mount the workpiece to ensure no rattling 2. Tighten all of the base connecting screws 3. Level the bench and add additional weights onto the bench to dampen the vibration. If possible, bolt the bench onto the floor. 4. Use a sharper bit or sharpen the dull bit 5. Refer to the speed chart

Electrical Issues

Symptom	Place to check	How to resolve
Drill press does not turn on (HMI Screen not lighting up)	<p>Firstly, unplug the drill press from its power source and check the following:</p> <ol style="list-style-type: none"> 1. Fuse 2. Damage to the power cable 3. Open the top cover and check all of the connection is secure on the main board. 4. Remove the plastic interface unit and check the ribbon cable connection. <p>Note: Make sure to securely fasten every component back together before connecting the drill press back into power again.</p>	<p>If all connection is connected securely and if there is no light on the HMI screen, the main control board inside the headstock may be dysfunctional.</p> <p>Contact our customer services for further assistance.</p>

Error Codes

Errors are indicated on the NOVA Viking Drill Press by the HMI screen displaying “Er” followed by the error code.

Example:

The motor is stopped when an error is displayed on the screen.

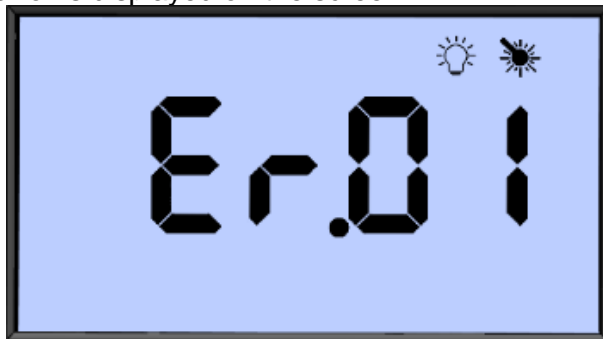

The table below shows the possible error codes which can be displayed.

Error code	Error Description
01	Over Voltage
02	Over Current
03	Motor running too fast
04	Motor not starting
05	Rotation position sensor error
06	Motor too hot
07	Main control board too hot

If an error code is displayed and drill press becomes unusable, please contact our customer services along with the error code that is being displayed.

NOVA Customer Services: service@teknatool.com (All enquiries must be in writing)

Teknatool Warranty



NOVA Limited Warranty

4499 126th St North | Clearwater Florida 33762
 teknatool.com | 727.954.3433

This NOVA product is backed by a registered warranty from the date of purchase and only to the original purchaser. These limited warranties are non-transferable. Under no circumstances will Teknatool International Ltd or Teknatool USA Inc. be liable for incidental, special, indirect, and consequential damages or expenses, including loss of profits or loss of operations.

INSPECTION: Buyer shall inspect all goods within thirty (30) days of receiving product confirming all parts are in good condition and accounted.

GUARANTEE: Teknatool International Ltd and Teknatool USA Inc. will repair or replace, at its expense and option, a NOVA product which under normal use and intended operation, has proven to be defective in workmanship or material. Teknatool will be granted a reasonable opportunity to verify the alleged defect by inspection and testing. Teknatool will not be responsible for any asserted defect, which has resulted from normal wear, misuse, abuse, power surges or excess voltage fluctuation, or using in a manner or with material not consistent with proper use, repair or alteration made by anyone other than an authorized service facility or representative.

Under these Limited Warranties, the sole liability of Teknatool is limited to repair, or at its option, replacement the applicable product or part not in conformity with these Limited Warranties. REFUNDS ARE NOT AVAILABLE. If within the warranty period, identical materials are unavailable at the time of repair or replacement, *IN NO EVENT SHALL NOVA TEKNATOOL'S RESPONSIBILITY EXCEED THE PURCHASE PRICE OF THE PRODUCT OR ITS REPLACEMENT AND RESERVES THE RIGHT TO USE REFURBISHED PARTS.*

CONDITIONS: Prior warranty registration is not required but advised via <https://www.teknatool.com/register-your-warranty/>; however, documented proof of purchase (sales receipt/invoice showing date, location, and purchase price paid) must be provided at the time of claim. **Repairs are charged hourly. In addition, customer pays for shipping to/from and provides own shipping contain; **Warranty Repairs: customer pays for shipping to/from and provides own shipping container; repairs are covered within warranty.*

OVERSEAS CUSTOMERS: Our NOVA Distributors and agents will issue their own warranty to cover this product. Terms may vary from those stated above; please check with your dealer. In North America, the warranty covers the Continental USA only. For Alaska, Hawaii and other areas, warranty covers replacement of parts only and excludes transport costs.

Product	Electrical	Mechanical
All Lathes and *Accessories (except COMET) Comet I & II Drill Presses and *Accessories <i>*Excludes belts and consumables</i>	2 years 1 year 2 years	5 years 2 years 5 years
All Chucks & Accessories Jaws	- -	6 years 6 years
Chisels: -Dovetail -Smart Chisel Handle	-	2 years 1 year

TO FILE A CLAIM: Contact CUSTOMER SERVICE via <https://www.teknatool.com/contact-us/> or support@teknatool.com with a full description for claim to include pictures/videos. All claims must include the original bill of sale, the product serial number (when available), and be filed within the applicable warranty period. Teknatool reserves the right to require defective parts be returned upon request. You must make arrangements with Teknatool to schedule the transportation of the parts from your home to the retailer or from the retailer to your home. A RETURN GOODS (RG) form will be sent to you via email. Items shipped to Teknatool without a RG form will be refused at shipper's expense. If the retailer from which you purchased the product is not able to service your product, contact Teknatool in writing at service@teknatool.com.

Our policy is one of continuous improvement. We therefore reserve the right to change specification/design without notice. This warranty is Teknatool International Ltd and Teknatool USA Inc. sole warranty whether written or verbal, whether expressed or implied by law, trade, custom, or otherwise, whether of merchantability, fitness for purpose, or otherwise, except for remedies available to customers under the Consumer Guarantees Act or other legislation

Viking Drill Press Headstock Breakdown

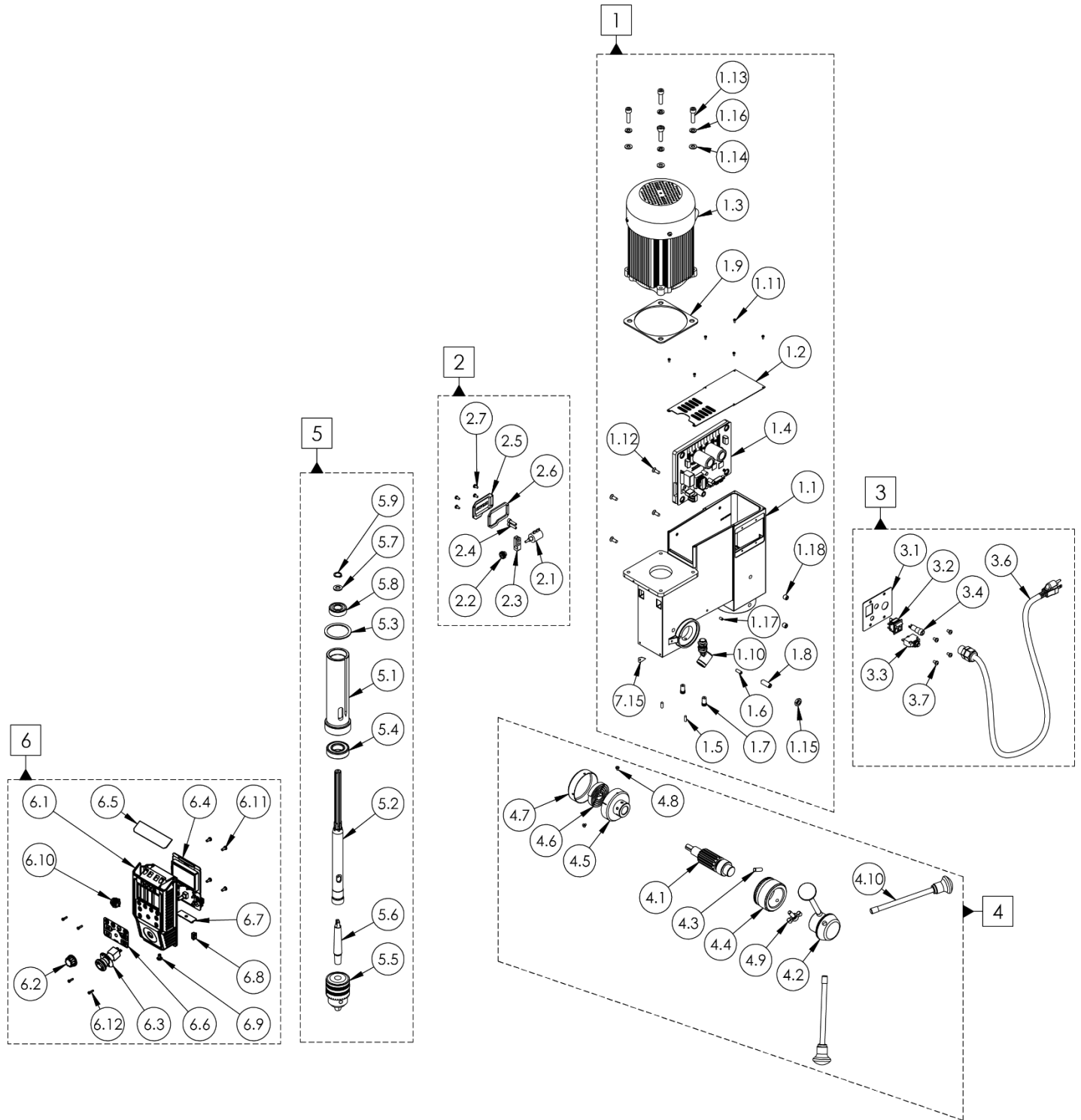

Viking Drill Press Stand and Base

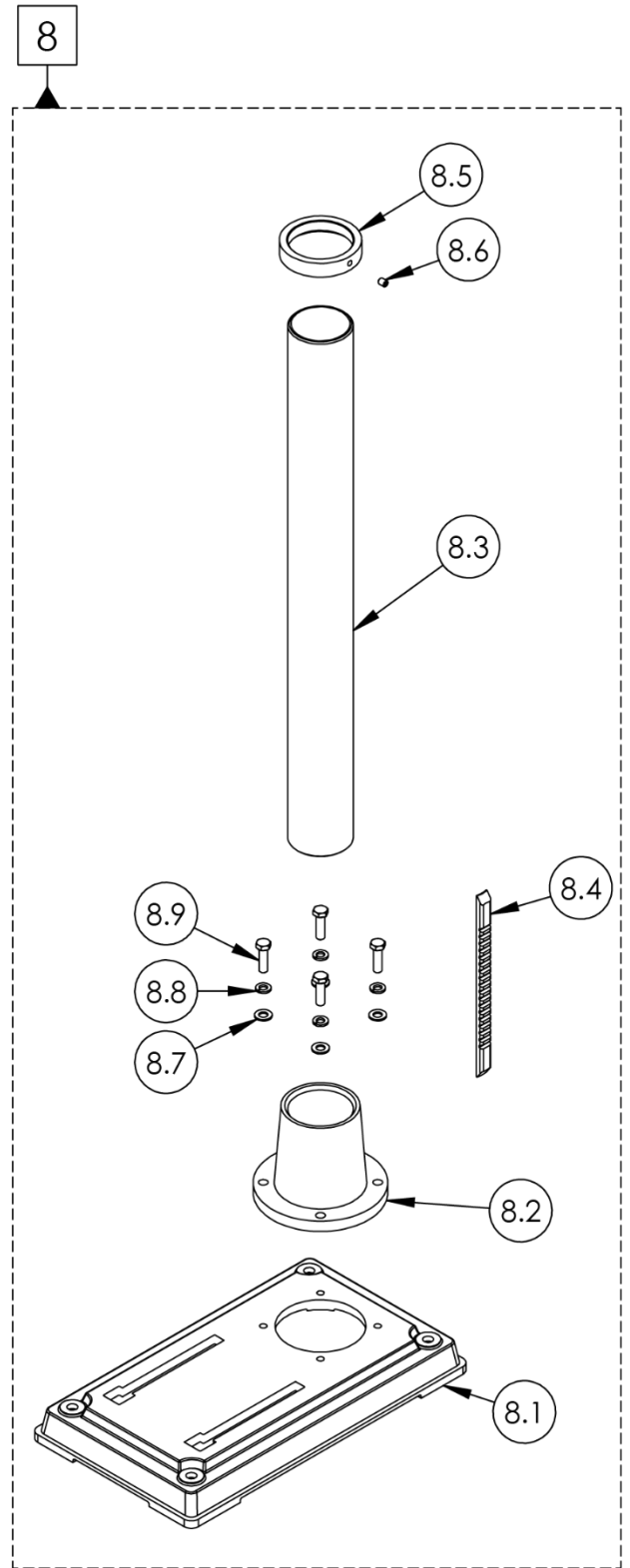
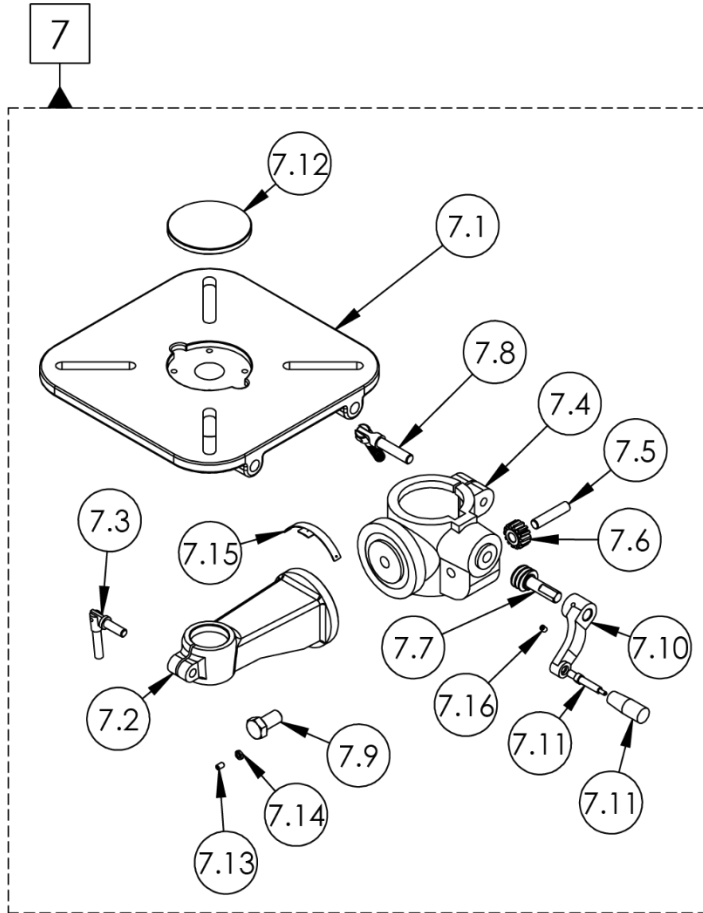

NOVA Viking Drill Press Parts List

ITEM NO.	Description	SKU	QTY.
1	Headstock Assembly	8379001	
1.1	16inch Drill Press Headstock Casting	8379011	1
1.2	Sheet metal top cover	8379013	1
1.3	1HP DVR Motor	8379001	1
1.4	Main Control Board	55448	1
1.5	Spring Base Locking Screw	8379035	2
1.6	Mechanical Stop Pin	8379039	1
1.7	Laser Module	8379043	2
1.8	Quill Pin	8379045	1
1.9	Motor Rubber Gasket	8379051	1
1.10	LED Light	8379056	1
1.11	Cross Head Screws M3x6	MPB0306	6
1.12	Main Board Locking Screw	CM0616	4
1.13	Motor Mounting Bolts M8x35	C08035	4
1.14	Motor Mount Bolt Flat Washer 8mm	FW08	4
1.15	Quill Pin Nut	NH10	1
1.16	Motor Mount Bolt Spring Lock Washer 8mm	SW08	4
1.17	Laser Locking Grub Screw	SZ0508	2
1.18	Headstock Locking Grub Screw	SZ1010	2
2	Depth Sensor Assembly	8379002	
2.1	Depth Sensor	8379072	1
2.2	Depth Sensor Gear	8379048	1
2.3	Depth Sensor Mounting Block	8379049	1
2.4	Depth Sensor Mounting Screw	C05020	2
2.5	Depth Sensor Cover	8379012	1
2.6	Depth Sensor Cover Gasket	8379050	1
2.7	Pan Cross Head Screw M4x8	MPB0408	4
3	Power Plate Assembly	8379003	
3.1	Main Power Plate	8379017	1
3.2	Main Power Switch	8379060	1
3.3	Thermal Breaker	5668006	1
3.4	Fuse	55404	1
3.5 & 3.6	Cable Gland	8379046 & 55062	1
3.7	Pan Cross Head Screw M5x8	MPB0508	4

4	Handle Assembly	879004	1
4.1	Handle Pinion Shaft	8379032	1
4.2	Handle Boss	8379031	1
4.3	Handle Pinion Dowel	DW0825	1
4.4	Mechanical Stop Sleeve	8379027	1
4.5	Spring Base	8379033	1
4.6	Return Spring	8379041	1
4.7	Spring Cover	8379030	1
4.8	Return Spring Cover Screw	MPB0406	2
4.9	Mechanical Stop Lock Knob	8379040	1
4.10	Handle	8379044	3
5	4.5inch Quill and Spindle Assembly	8379005	
5.1	Drill Press Quill	8379016	1
5.2	Spindle	8379015	1
5.3	Quill Rubber Space Washer	RW45	1
5.4	6205 Ball Bearing	6205LLB	1
5.5	Drill Press Chuck	8379068	1
5.6	Arbor	8379019	1
5.7	Flat Washer 17mm	FW17	1
5.8	6004 Ball Bearing	6004LLB	1
5.9	Spindle Retaining Circlip	EC15	1
6	HMI Control Panel Assembly	8379009	
6.1	Drill Press HMI Plastic Panel	8379014	1
6.2	Speed Dial	8379076	1
6.3	EMS	8379047	1
6.4	Interface Board with LCD	55447	1
6.5	HMI Top Plate	8379075	1
6.6	Drill Press Keypad Membrane	8379018	1
6.7	LED Lights Board	55451	1
6.8	USB Rubber Cap	8379077	1
6.9	Plastic Rivet	8379074	1
6.10	Interlock chuck guard female connector	55526	1
6.11	HMI Board Mounting Screw	MPB0412	4
6.12	HMI Panel Mounting Screw	MPB0312	4
7	Table Assembly	8379007	
7.1	Drill Press Table	8379022	1
7.2	Table Arm	8379023	1

7.3	Table Locking Handle	8379064	1
7.4	Table Column Bracket	8379021	1
7.5	Gear Shaft	8379065	1
7.6	Table Rack Gear	8379034	1
7.7	Table Rack Worm Gear	8379036	1
7.8	Clamp Lock Handle	8379020	1
7.9	Hex Bolt M16x30	BNMZ16030	1
7.10	Table Handle Arm	8379028	1
7.11	Handle	8379070	1
7.12	Table Insert	8379024	1
7.13	Table Arm Locking Screw	SZ0630	1
7.14	Table Arm Locking Nut M6	NH06	1
7.15	Aluminium Scale Plate Set	837078	1
7.16	Table Column Bracket Handle Grub Screw	SZ0608	1
8 Base Assembly 8379008			
8.1	Drill Press Base	8379025	1
8.2	Drill Press Column Base	8379026	1
8.3	Drill Press Column	8379029	1
8.4	Rack	8379037	1
8.5	Rack Ring	8379038	1
8.6	Base Column Ring Grub Screw	SZ0810	1
8.7	Flat Washer 10mm	FW10	4
8.8	Spring Lock Washer 10mm	SW10	4
8.9	Hex Bolt M10x35	BNMZ10035	4

Chuck Guard

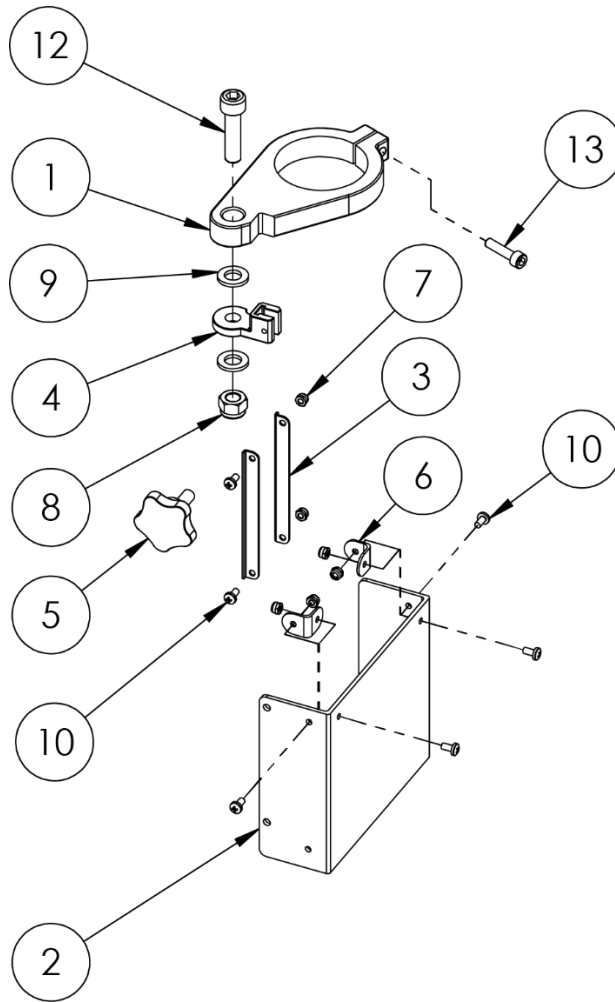

NOVA Viking Chuck Guard Assembly 8379009			
ITEM NO.	Description	SKU	QTY.
1	Chuck Guard Mount	8379096	1
2	Polycarbonate Guard	8379097	1
3	Chuck Guard Slide Rack	8379098	2
4	Chuck Guard Slide Mount	8379099	1
5	Guard Slide Lock	8379100	1
6	Guard Support Plate	8379101	2
7	Nyloc Nuts M4	NN04	6
8	Nyloc Nut M10	NN10	1
9	10mm Flat Washer	FW10	2
10	Guard Fastening Screws M4x8	MPB0408	6
12	Guard Pivot Bolt M10	C10040	1
13	Guard Mount Locking Bolt M6x25	C06025	1

Appendix

NOVA Viking Wiring Diagram

IMPORTANT
 Supplement to Manual, Publication Code 123-0516-001

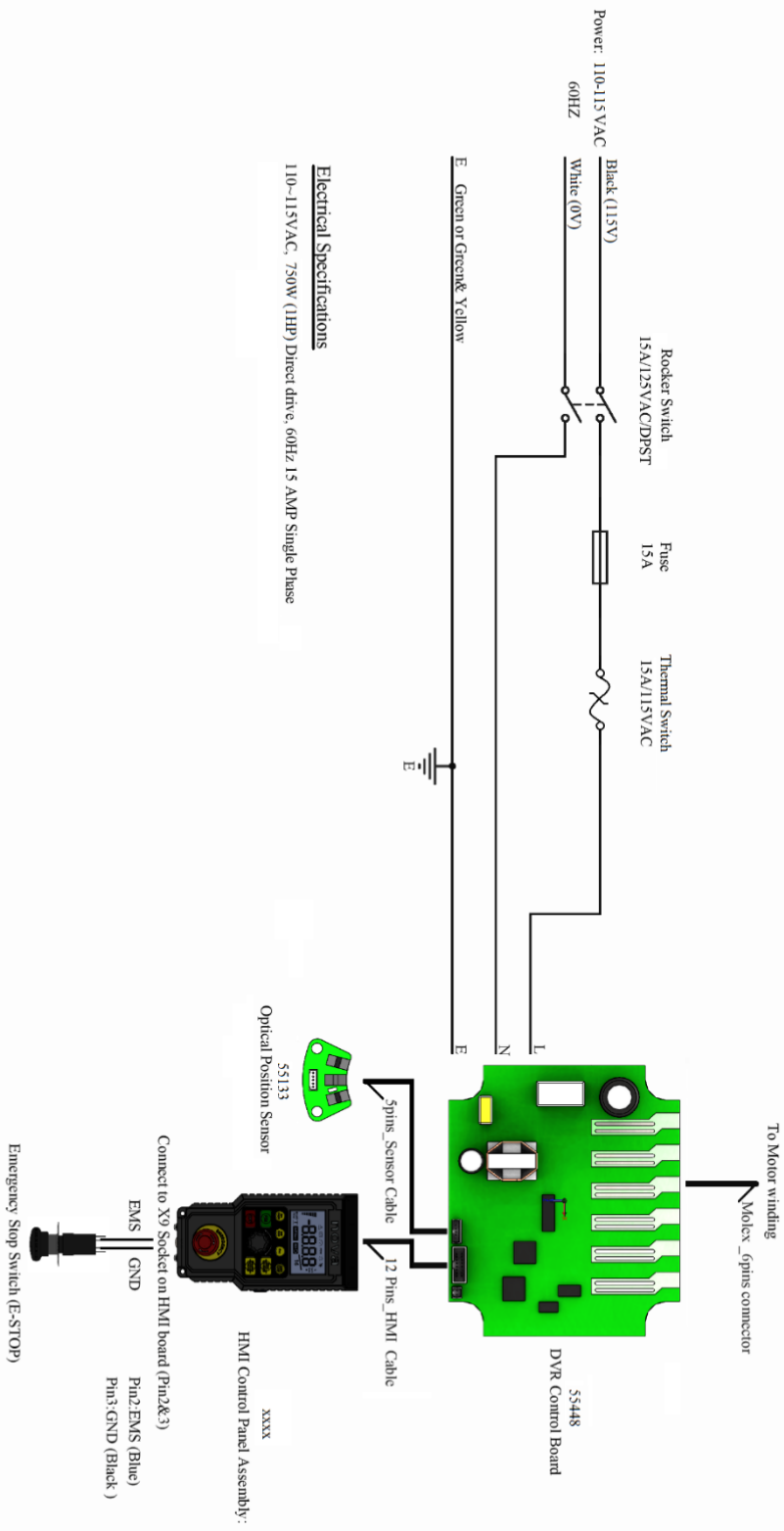

Electrical Specifications
 110-115VAC, 750W (1HP) Direct drive, 60Hz, 15 AMP Single Phase

Title		Electrical Wiring Diagram_NOVA Viking DVR Drill Press	
Size	Number	Revision	
A	115VAC60HZ	REV01	
Date:	14/09/2018	Sheet of	No. 1 of 1
File:		Drawn By:	will

Using the included accessories

Chuck Drift

The chuck drift is used to knock out the Morse Tapered tools that are attached into the drill press quill

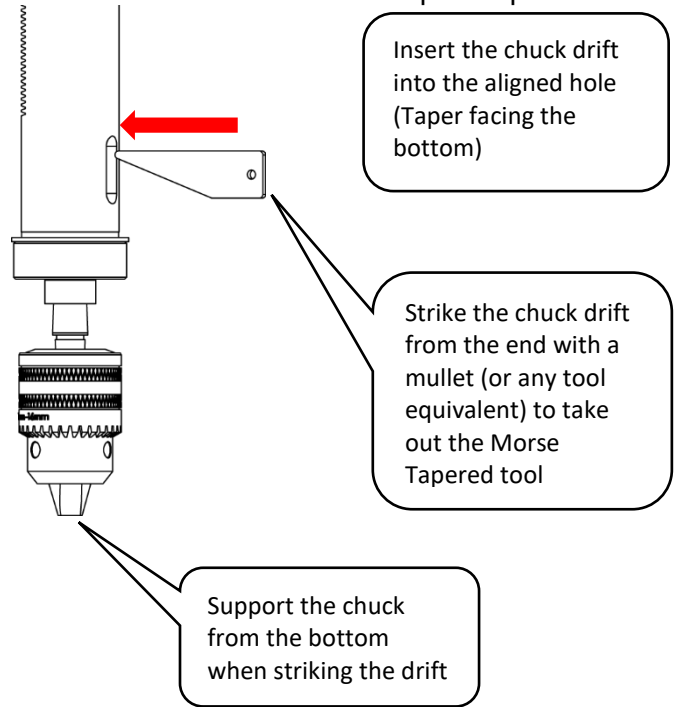
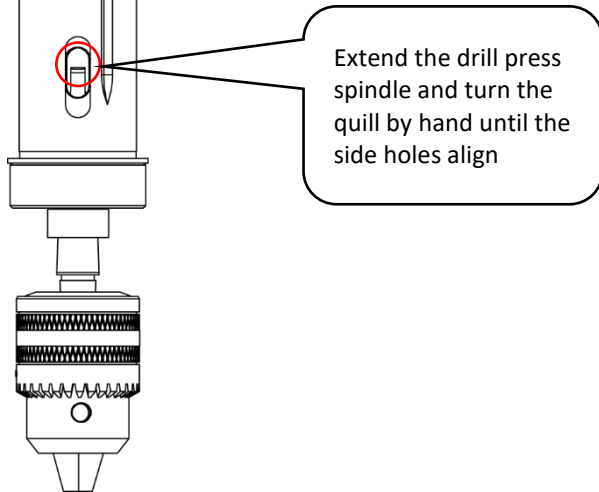



11 July 2019

NOVA Viking DVR 16" Benchtop Drill Press Manual
123-0719-018

© Teknatool® International 2019
All rights reserved. Teknatool® USA Inc.